

SHARP

Projector

A104U-W/A104U-B A824U-W/A824U-B

Installation Manual

When using the XP-43ZL/NP43ZL lens unit:

This projector is intended for professional use and must be installed by professional installer to ensure safety.

Dealers and installers must read this manual.

HDMI™

HDBT™
ASE

Model No.

XP-A104U-W/XP-A104U-B/XP-A824U-W/XP-A824U-B

Table of Contents

Introduction	iv
Important Information	v
1. Check the product overview, supplied items and part names	1
1-1. Introduction to the Projector	1
1-2. What's in the Box?	4
1-3. Part Names of the Projector	5
1-4. Part Names of the Remote Control	11
2. Projecting an Image (Basic Operation)	18
2-1. Flow of Projecting an Image	18
2-2. Connecting Your Computer/Connecting the Power Cord	19
2-3. Turning on the Projector	22
2-4. Selecting a Source	25
2-5. Adjusting the Picture Size and Position	27
2-6. Adjusting a picture and sound	35
2-7. Turning off the Projector	36
2-8. After Use	37
3. Convenient Features	38
3-1. Turn off the light of the projector (SHUTTER)	38
3-2. Turning Off the On-Screen Menu (On-Screen Mute)	38
3-3. Enlarging a Picture	39
3-4. Adjustment of luminance (brightness)	40
3-5. Correcting Horizontal and Vertical Keystone Distortion [CORNERSTONE]	44
3-6. Operation for the On-Screen Menu by a commercially available USB mouse	47
3-7. Preventing the Unauthorized Use of the Projector [START-UP LOCK]	49
3-8. Controlling the Projector by Using an HTTP Browser	52
3-9. Storing Changes for Lens Shift, Zoom, and Focus [LENS MEMORY]	55

4. Multi-Screen Projection	62
4-1. Things that can be done using multi-screen projection	62
4-2. Using a single projector to project two types of videos at the same time [PIP/ PICTURE BY PICTURE]	63
4-3. Line up multiple projectors to display a high resolution image in a larger screen [TILING]	67
4-4. Adjust boundaries of a projected image [EDGE BLENDING]	69
5. Using On-Screen Menu	78
5-1. Using the Menus	78
5-2. Menu Elements	79
5-3. List of Menu Items	81
5-4. Menu Descriptions & Functions [INPUT]	89
5-5. Menu Descriptions & Functions [ADJUST]	93
5-6. Menu Descriptions & Functions [DISPLAY]	105
5-7. Menu Descriptions & Functions [SETUP]	116
5-8. Menu Descriptions & Functions [INFO.]	144
6. Attachment/detachment of parts sold separately	147
6-1. Lens unit	147
6-2. Cable cover	151
7. Connecting to Other Equipment	155
7-1. Connecting Your Computer	156
7-2. Connecting audio video equipment	157
7-3. Connecting to a HDBaseT transmission device (sold commercially)	158
7-4. Connecting to a Wired LAN	159
7-5. Connecting several projectors	160
8. Maintenance	162
8-1. Cleaning the Lens	162
8-2. Cleaning the Cabinet	163

9. Appendix 164

 9-1. Throw distance and screen size 164

 9-2. Compatible Input Signal List 172

 9-3. Specifications 174

 9-4. Cabinet Dimensions 177

 9-5. Pin assignments and signal names of main connectors 178

 9-6. Portrait projection (vertical orientation) 180

 9-7. Troubleshooting 182

 9-8. PC Control Codes and Cable Connection 188

 9-9. About the ASCII Control Command 190

 9-10. List of Art-Net DMX parameters 192

 9-11. Troubleshooting Check List 193

Introduction

Thank you for purchasing the projector.

This projector can be connected to computers, video devices, etc. to project images sharply onto a screen.

Please read this manual carefully before using your projector.

Read this manual if you have any doubts about operation or if you believe the projector may be faulty.

NOTES

- (1) The contents of this manual may not be reprinted in part or whole without permission.
- (2) The contents of this manual are subject to change without notice.
- (3) Great care has been taken in the preparation of this manual; however, should you notice any questionable points, errors or omissions, please contact us.
- (4) The image shown in this manual is indicative only. If there is inconsistency between the image and the actual product, the actual product shall govern.
- (5) Notwithstanding article (3) and (4), we will not be responsible for any claims on loss of profit or other matters deemed to result from using this device.
- (6) This manual is commonly provided to all regions so they may contain descriptions that are pertinent for other countries.

Important Information

Supplier's Declaration of Conformity

SHARP PROJECTOR, XP-A104U-W/XP-A104U-B/XP-A824U-W/XP-A824U-B

This device complies with Part 15 of the FCC Rules. Operation is subject to the following two conditions: (1) This device may not cause harmful interference, and (2) this device must accept any interference received, including interference that may cause undesired operation.

Responsible Party: SHARP ELECTRONICS CORPORATION
100 Paragon Drive, Montvale, NJ 07645
TEL: 1-888-GO-SHARP / 1-888-467-4277 www.sharppusa.com

WARNING:

FCC Regulations state that any unauthorized changes or modifications to this equipment not expressly approved by the manufacturer could void the user's authority to operate this equipment.

NOTE:

This equipment has been tested and found to comply with the limits for a Class A digital device, pursuant to Part 15 of the FCC Rules. These limits are designed to provide reasonable protection against harmful interference when the equipment is operated in a commercial environment. This equipment generates, uses, and can radiate radio frequency energy and, if not installed and used in accordance with the instruction manual, may cause harmful interference to radio communications.

Operation of this equipment in a residential area is likely to cause harmful interference in which case the user will be required to correct the interference at his own expense.

U.S.A. ONLY

Cable information

Use shielded cables to prevent interference with radio or television reception.

Notice Concerning Electromagnetic Interference (EMI) (For other regions)

WARNING:

Operation of this equipment in a residential environment could cause radio interference.

(For Customers in U.K.)

IMPORTANT

- The wires in this mains lead are coloured in accordance with the following code:

GREEN-AND-YELLOW:	“Earth”
BLUE:	“Neutral”
BROWN:	“Live”

- As the colours of the wires in the mains lead of this apparatus may not correspond with the coloured markings identifying the terminals in your plug proceed as follows:
- The wire which is coloured GREEN-AND-YELLOW must be connected to the terminal in the plug which is marked by the letter **E** or by the safety earth symbol \perp or coloured green or green-and-yellow.
- The wire which is coloured BLUE must be connected to the terminal which is marked with the letter **N** or coloured black.
- The wire which is coloured BROWN must be connected to the terminal which is marked with the letter **L** or coloured red.
- Ensure that your equipment is connected correctly. If you are in any doubt consult a qualified electrician.

“WARNING: THIS APPARATUS MUST BE EARTHED.”



Information on the Disposal of this Equipment and its Batteries

IF YOU WISH TO DISPOSE OF THIS EQUIPMENT OR ITS BATTERIES, DO NOT USE THE ORDINARY WASTE BIN, AND DO NOT PUT THEM INTO A FIREPLACE!

Used electrical and electronic equipment and batteries should always be collected and treated SEPARATELY in accordance with local law.

Separate collection promotes an environment-friendly treatment, recycling of materials, and minimizing final disposal of waste. IMPROPER DISPOSAL can be harmful to human health and the environment due to certain substances! Take USED EQUIPMENT to a local, usually municipal, collection facility, where available.

Remove USED BATTERIES from equipment, and take them to a battery collection facility; usually a place where new batteries are sold.

If in doubt about disposal, contact your local authorities or dealer and ask for the correct method of disposal.

ONLY FOR USERS IN THE EUROPEAN UNION, AND SOME OTHER COUNTRIES; FOR INSTANCE NORWAY AND SWITZERLAND: Your participation in separate collection is requested by law.

The symbol shown above appears on electrical and electronic equipment and batteries (or the packaging) to remind users of this. If 'Hg' or 'Pb' appears below the symbol, this means that the battery contains traces of mercury (Hg) or lead (Pb), respectively.

Users from PRIVATE HOUSEHOLDS are requested to use existing return facilities for used equipment and batteries.

Batteries are collected at points of sale. Return is free of charge.

If the equipment has been used for BUSINESS PURPOSES, please contact your SHARP dealer who will inform you about take-back. You might be charged for the costs arising from take-back. Small equipment (and small quantities) might be taken back by your local collection facility.

For Spain: Please contact the established collection system or your local authority for take-back of your used products.

(for Germany only)

Machine Noise Information Regulation - 3. GPSGV,

The highest sound pressure level is less than 70 dB (A) in accordance with EN ISO 7779.



Information of the AUDIO OUT mini jack

The AUDIO OUT mini jack does not support earphone/headphone terminal.









About the symbols

To ensure safe and proper use of the product, this manual uses a number of symbols to prevent injury to you and others as well as damage to property.

The symbols and their meanings are described below. Be sure to understand them thoroughly before reading this manual.

 WARNING	Failing to heed this symbol and handling the product erroneously could result in accidents leading to death or major injury.
 CAUTION	Failing to heed this symbol and handling the product erroneously could result in personal injury or damage to surrounding property.

Examples of symbols

	This symbol indicates you should be careful of electric shocks.
	This symbol indicates you should be careful of high temperatures.
	This symbol indicates something that must be prohibited.
	This symbol indicates something that must not be got wet.
	This symbol indicates you should not touch with wet hands.
	This symbol indicates something that must not be disassembled.
	This symbol indicates things you must do.
	This symbol indicates that the power cord should be unplugged from the power outlet.

Safety Cautions

WARNING

Projected light



PROHIBITED

Projected light and the pictogram/label indicated on the cabinet

- Do not look into the projector's lens.
Strong light that could damage your vision is projected when the projector is operating. Laser energy exposure near aperture may cause burns. Be especially careful when children are around.
- Do not look at the projected light using optical devices (magnifying glasses, reflectors, etc.). Doing so could result in vision impairment.
- Check that there is no one looking at the lens within the projection range before turning on the projector.
- The below pictogram, that is indicated near the lens on the cabinet, describes looking into the projector is prohibited.

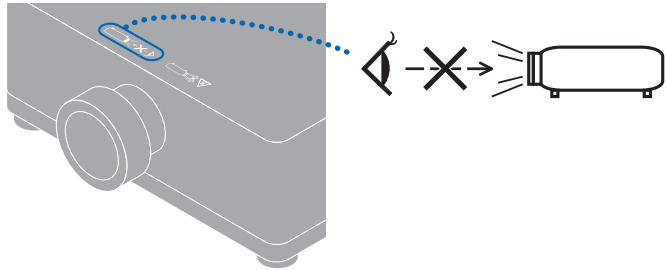

Continue to next page

WARNING

- The following labels are stuck on the projector.

Label 1
Laser explanatory label



This product complies with EN 50689:2021 except using the lenses of XP-43ZL and NP43ZL.

Label 2
FDA additional warning label

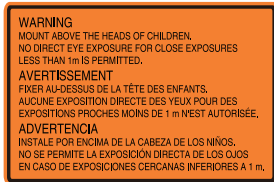

Label 3
Lens replacement caution label

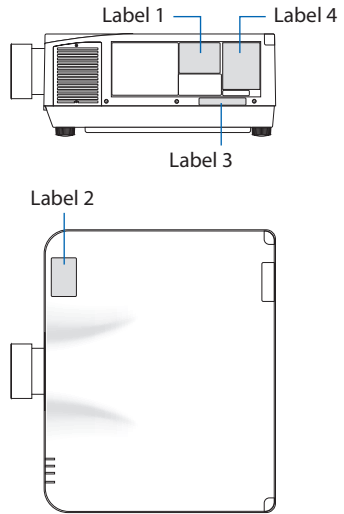

Label 3
FDA certification label

This product is in conformity with performance standards for laser products under 21 CFR 1040, except with respect to those characteristics authorized by Variance Number FDA-2018-4-4413 effective on September 19, 2023.

A824U-W/A824U-B



 **WARNING**

- This projector is classified as either IEC/EN 62471-5:2015 risk group 2 or risk group 3 depending on the lens unit. When classified as risk group 3, this projector is intended for professional use and must be installed by professional installer to ensure safety. See page [xxi](#) for risk groups.
- See page [xx](#) for Laser Safety Caution.

Power supply



REQUIRED

Use a suitable voltage power supply.

- This projector is designed to be used with a 100–240 VAC, 50/60 Hz power supply. Before using the projector, check that the power supply to which the projector is to be connected meets these requirements.
- Use a power outlet as the projector's power supply. Do not connect the projector directly to electrical light wiring. Doing so is dangerous.



MUST BE EARTHED

Connecting the power cord to earth

- This equipment is designed to be used in the condition of the power cord connected to earth. If the power cord is not connected to the earth, it may cause electric shock. Please make sure the power cord is connected to the wall outlet directly and earthed properly. Do not use a 2-pin plug converter adapter.
- Be sure to connect the projector and the computer (signal source) to the same earth point. If the projector and the computer (signal source) will be connected to different earth points, fluctuations in the earth potential may cause fire or smoke.



REQUIRED

Handling the power cord

- Please use the power cord supplied with this projector. If the supplied power cord does not satisfy requirements of your country's safety standard, and voltage and current for your region, make sure to use the power cord that conforms to and satisfies them.

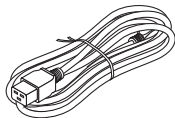

- The power cord you use must be approved by and comply with the safety standards of your country. Please refer to the page [175](#) about the power cord specification. For selecting an appropriate power cord, please check rated voltage for your region by yourself.



PROHIBITED

- The power cord included with this projector is exclusively for use with this projector. For safety, do not use it with other devices.

Continue to next page

 **WARNING**



**HAZARDOUS
VOLTAGE**

- Handle the power cord with care. Damaging the cord could lead to fire or electric shock.
 - Do not place heavy objects on the cord.
 - Do not place the cord under the projector.
 - Do not cover the cord with a rug, etc.
 - Do not scratch or modify the cord.
 - Do not bend, twist or pull the cord with excessive force.
 - Do not apply heat to the cord.
- Should the cord be damaged (exposed core wires, broken wires, etc.), ask your dealer to replace it.
- Do not touch the power plug should you hear thunder. Doing so could result in electric shock.
- Do not connect or disconnect the power cord with wet hands. Doing so could result in electric shock.



**DO NOT TOUCH
WITH WET
HANDS**

Installation



PROHIBITED

Do not use in places such as those described below.







- Do not use in places such as those described below. Doing so could lead to fire or electric shock.
 - Shaky tables, inclined surfaces or other unstable places.
 - Poorly ventilated spaces.
 - Near a radiator, other heat sources, or in direct sunshine.
 - Continual vibration areas.
 - Humid, dusty, steamy, or oily areas.
 - An environment where there are corrosive gases (sulfur dioxide, hydrogen sulfide, nitrogen dioxide, chlorine, ammonia, ozone, etc.).
 - Outdoors.
 - High-temperature environment where humidity changes rapidly and condensation is likely to occur.
 - Do not use in places such as those described below where the projector could get wet. Doing so could lead to fire or electric shock.
 - Do not use in the rain or snow, on a seashore or waterfront, etc.
 - Do not use in a bathroom or shower room.
 - Do not install under equipment that discharges water, such as air conditioners.
 - Do not place vases or potted plants on the projector.
 - Do not place cups, cosmetics or medicines on the projector.
- Should water, etc. get inside the projector, first turn off the projector's power, then unplug the power cord from the power outlet and contact your dealer.









DO NOT WET









**UNPLUG THE
POWER CORD**

 WARNING	
 CAUTION	<p>Installing suspended from the ceiling</p> <ul style="list-style-type: none"> • Consult your dealer for installing the projector on the ceiling. Special skills are required for ceiling installation. DO NOT perform installation work by people other than installers. Doing so may result in the projector falling and causing injury. • We are not liable for any accident or/and damage resulting from improper installation or handling, misuse, modification, or natural disasters. • When installed suspended from the ceiling, etc. do not hang from the projector. The projector could drop and cause injury. • When installing suspended from the ceiling, use a power outlet that is within reach so the power cord can be easily plugged and unplugged.
 REQUIRED  PROHIBITED	<p>Attach the separately sold option cover for tilted installation</p> <ul style="list-style-type: none"> • For tilted installation of the projector, depending on the angle, be sure to attach the separately sold option cover for safety. (→ page xxix) Using without the option cover violates safety regulations. Also, powering the projector on without the option cover installed could result in a fire. • Do not put bundled cables in the option cover. Doing so may damage the power cord, resulting in a fire.
On use	
 PROHIBITED  UNPLUG THE POWER CORD	<p>Do not place objects inside the projector.</p> <ul style="list-style-type: none"> • Do not insert or drop metal or combustible objects or other foreign materials into the projector from the vents. Doing so could lead to fire or electric shock. Be particularly careful if there are children in the home. Should a foreign object get inside the projector, first turn off the projector's power, then unplug the power cord from the power outlet and contact your dealer.
 UNPLUG THE POWER CORD	<p>Unplug the power cord if the projector malfunctions.</p> <ul style="list-style-type: none"> • Should the projector emit smoke or strange odors or sounds, or if the projector has been dropped or the cabinet broken, turn off the projector's power, then unplug the power cord from the power outlet. Otherwise it may cause not only fire or electric shock but also serious damage to your eyesight or burns. Contact your dealer for repairs. Never try to repair the projector on your own. Doing so is dangerous.

 WARNING	
 DO NOT DISASSEMBLE	<p>Do not disassemble the projector.</p> <ul style="list-style-type: none"> Do not remove or open the projector's cabinet. Also, do not modify the projector. There are high voltage areas in the projector. It may cause fire, electric shock, or laser light leakage, resulting in serious damage to your eyesight or burns. Have qualified service personnel perform inspection, adjustments and repairs of the interior.
 PROHIBITED  CAUTION FOR HIGH TEMPERATURE	<p>Do not place objects in front of the lens while the projector is operating.</p> <ul style="list-style-type: none"> Do not leave the lens cap on the lens while the projector is operating. The lens cap could get hot and be warped. Do not place objects in front of the lens that obstruct the light while the projector is operating. The object could get hot and be broken or catch fire. The below pictogram indicated on the cabinet means the precaution for avoiding to place objects in front of the projector lens. <div style="text-align: center;">  </div>
 PROHIBITED	<p>When cleaning the projector</p> <ul style="list-style-type: none"> Do not use flammable gas sprays to remove dust from the lens, cabinet, etc. Doing so could lead to fire.
 PROHIBITED	<p>Do not use in high security locations.</p> <ul style="list-style-type: none"> Usage of the product must not be accompanied by fatal risks or dangers that, could lead directly to death, personal injury, severe physical damage or other loss, including nuclear reaction control in nuclear facility, medical life support system, and missile launch control in a weapon system.

 **CAUTION**

Power cord	
 REQUIRED	<p>Handling the power cord</p> <ul style="list-style-type: none"> • The projector should be installed close to an easily accessible power outlet. • When connecting the power cord to the projector's AC IN terminal, make sure the connector is fully and firmly inserted. Be sure to fix the power cord using the power cord stopper. Loose connection of the power cord could lead to fire or electric shock.
 REQUIRED  UNPLUG THE POWER CORD	<p>Handling the power cord by following below to avoid fire or electric shock</p> <ul style="list-style-type: none"> • When disconnecting the power cord, pull the power cord out by holding onto its plug. • Unplug the power cord from the power outlet before cleaning the product or when not planning to use the product for an extended time. • When the power cord or plug is heat or damaged, unplug the power cord from the power outlet, and contact your dealer.
 REQUIRED	<p>Periodically clean dust and other debris from the power plug</p> <ul style="list-style-type: none"> • Failure to do so could result in fire or electric shock.
 REQUIRED	<p>Disconnect power cords and other cables before moving the projector</p> <ul style="list-style-type: none"> • Before moving the product, make sure the product power is off, then unplug the power cord from the power outlet and check that all cables connecting the product to other devices are disconnected.
 PROHIBITED	<p>Do not use the power cord with a power tap</p> <ul style="list-style-type: none"> • Adding an extension cord may lead to fire as a result of overheating.

 **CAUTION**

Installation



REQUIRED

Securing the lens unit with the fall prevention wire

- If the projector is going to be suspended from a ceiling or another high place, secure the lens unit using the fall prevention wire (sold separately). If the lens unit is not secured, it may fall down if it comes loose.

On use



PROHIBITED

Do not use on networks subject to overvoltage.

- Connect the projector's HDBaseT port and LAN port to a network for which there is no risk of overvoltage being applied. Overvoltage applied to the HDBaseT or LAN port could result in electric shock.



REQUIRED

Lens shift, focus and zoom operations

- When shifting the lens or adjusting the focus or zoom, do so from either behind or the side of the projector. If adjustments are performed from the front, your eyes could be exposed to strong light and get injured.
- Keep your hands away from the lens area when performing the lens shift operation. If not, your fingers could get caught in the gap between the cabinet and the lens.

 **CAUTION**



PROHIBITED

Handling batteries

Incorrect usage of batteries can result in leaks or bursting.

- Use the specified batteries only.
- Insert batteries matching the (+) and (-) signs on each battery to the (+) and (-) signs of the battery compartment.
- Do not mix battery brands.
- Do not combine new and old batteries. This can shorten battery life or cause liquid leakage of batteries.
- Remove dead batteries immediately to prevent battery acid from leaking into the battery compartment.

If leaked battery fluid gets on your skin or clothing, rinse immediately and thoroughly. If it gets into your eye, bathe your eye well rather than rubbing and seek medical treatment immediately. Leaked battery fluid that gets into your eye or your clothing may cause a skin irritation or damage your eye.

- If you will not use the remote control for a long time, remove the batteries.
- Leaving a battery in an extremely high temperature surrounding environment, or a battery subject to extremely low air pressure, that can result in an explosion or the leakage of flammable liquid or gas.
- Properly dispose of depleted batteries. Disposal of a battery into water, fire, or a hot oven, or mechanically crushing, cutting, or modifying a battery can result in an explosion.
- Do not short-circuit the batteries.
- Do not charge the batteries. The batteries provided are not rechargeable.
- Contact your dealer or local authorities when disposing of batteries.









PROHIBITED



**CAUTION
FOR HIGH
TEMPERATURE**

About the vents

- Do not obstruct the projector's vents. Also, do not place such soft objects as paper or cloths underneath the projector. Doing so could lead to fire. Leave sufficient space between the place where the projector is installed and its surroundings. (→ page xxxii)
- Do not touch the exhaust vent area while projecting or immediately after projecting images. The exhaust vent area may be hot at this time and touching it could cause burns.

 CAUTION	
 PROHIBITED	<p>Moving the projector</p> <ul style="list-style-type: none"> • When carrying the projector, remove the lens unit and carry it with at least two people. Attempting to move the projector alone could result in back pain or other injuries. • When carrying the projector with the lens unit removed, do not touch the mounting area of the lens with your hands. Also, do not put your hand into the recess of the connection terminal. The projector could be damaged or fall down, resulting in injuries. • When moving the projector with the option cover attached, do not hold it by the option cover. The option cover could come loose and the main unit could fall down, causing injuries.
 REQUIRED	<p>Attaching/detaching the lens</p> <ul style="list-style-type: none"> • Turn off the projector and disconnect the power cord before attaching or detaching the lens unit. Failure to do so could result in visual impairment or burns. • Do not attach or detach the lens unit with the projector installed in a high location. The lens unit could fall and cause damage or injury.
 PROHIBITED	<p>Do not push or climb on the product. Do not grab or hang onto the product. Do not rub or tap the product with hard objects.</p> <p>The product may fall, causing damage to the product or personal injury.</p>
 REQUIRED	<p>About option cover (separately sold)</p> <ul style="list-style-type: none"> • Be sure to tighten the screws after attaching the option cover. Failure to do so may cause the option cover to come off and fall, resulting in injury or damage to the option cover.
 PROHIBITED	
 REQUIRED	<p>Avoid locations with extreme temperatures and humidity</p> <ul style="list-style-type: none"> • Failure to do so could lead to fire or electric shock or damage to the projector. The usage environment for this projector is as follows: <ul style="list-style-type: none"> - The operating temperature: 0°C to 40°C / 32°F to 104°F / humidity: 20 to 80% (without condensation) - The storage temperature: -10°C to 50°C / 14°F to 122°F / humidity: 20 to 80% (without condensation)

 **CAUTION**

Inspections and Cleaning



REQUIRED

Inspecting the projector and cleaning the inside

- Consult with your dealer about once per year for cleaning of the inside of the projector. Dust could accumulate inside of the projector if it is not cleaned for extended periods of time, leading to fires or malfunction.

Laser Safety Caution** WARNING**

CLASS 1 LASER PRODUCT [IEC 60825-1:2014]

CLASS 1 CONSUMER LASER PRODUCT OF EN 60825-1:2014+A11:2021 (For EU and UK)

- The laser module is equipped in this product. Use of controls or adjustments of procedures other than those specified herein may result in hazardous radiation exposure. Laser energy exposure near aperture may cause burns.

- This product is classified as Class 1 of IEC60825-1:2014.
- For EU and UK
This product complies with EN 60825-1:2014+A11:2021.
This product also complies with EN 50689:2021 except using the lenses of XP-43ZL and NP43ZL.
- Obey the laws and regulations of your country in relation to the installation and management of the device.

For USA

Complies with 21 CFR 1040.10 and 1040.11 except for conformance as a Risk Group 2 LIP as defined in IEC 62471-5:Ed. 1.0. For more information see Laser Notice No. 57, dated May 8, 2019. However, when using the XP-43ZL and NP43ZL lenses, the following applies.

This product is in conformity with performance standards for laser products under 21 CFR 1040, except with respect to those characteristics authorized by Variance Number FDA-2018-V-4413 effective on September 19, 2023.

 WARNING

- Do not allow to look into the projector beam at any distance from the projector. An adult should supervise the children to prevent exposure risks.
- Check that there is no one looking at the lens, when using the remote control for starting the projector.
- Do not look at the projected light using optical devices(binoculars, telescopes, magnifying glasses, reflectors, etc).
- [WARNING: MOUNT ABOVE THE HEADS OF CHILDREN.]
The use of a ceiling mount is recommended with this product to place it above the eyes of children.

- Outline of laser emitted from the built-in light module:
 - Wave length: 455 nm
 - Maximum power: 257 W (A104U-W/A104U-B), 229 W (A824U-W/A824U-B)

Light Module

- A light module containing multiple laser diodes is equipped in the product as the light source.
- These laser diodes are sealed in the light module. No maintenance or service is required for the performance of the light module.
- End user is not allowed to replace the light module.
- Contact qualified distributor for light module replacement and further information.

Risk groups

This projector is classified as either IEC/EN 62471-5:2015 risk group 2 or risk group 3 depending on the lens unit.

Risk group 2 (RG2)

 **WARNING**

As with any bright light source, do not stare into the beam, RG2 IEC/EN 62471-5:2015.

Risk group 3 (RG3)

 **WARNING**

RG3 PRODUCT OF IEC/EN 62471-5:2015

- When classified as RG3, this projector is for professional use and must be installed in location where safety is assured. For this reason, be sure to consult your dealer as installation must be performed by a professional installer. Never try to install the projector by yourself. This may result in visual impairment etc.
- No direct exposure to the beam shall be permitted, RG3 IEC/EN 62471-5:2015.
- Do not look into the projector's lens. Serious damage to your eyes could result.
- Operators shall control access to the beam within the hazard distance or install the product at the height that will prevent exposures of spectators' eyes within the hazard distance.
- When turning on the power, operate from the side or rear of the projector (outside the hazard zone). Also, when turning on the power, make sure no one within the projection range is looking at the lens.

• Check before installing the projector

① Lens model name or throw ratio

The lens unit model or throw ratio is listed at one of the locations in  in the images below.

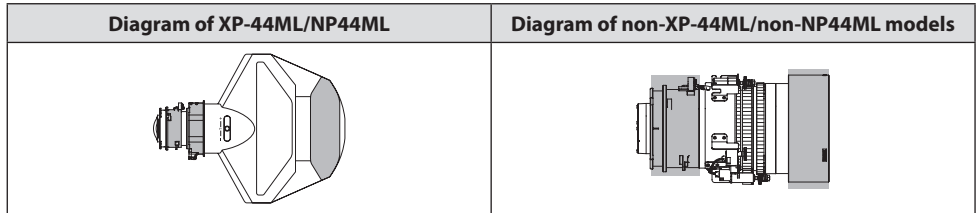

② Combining lens units and risk groups

Lens model name	Throw ratio	A104U-W/A104U-B	A824U-W/A824U-B
XP-40ZL/NP40ZL	0.79 - 1.11	RG2	RG2
XP-41ZL/NP41ZL	1.30 - 3.02		
XP-50ZL/NP50ZL	0.60 - 0.75		
XP-44ML/NP44ML	0.32	RG3	RG3
XP-43ZL/NP43ZL	2.99 - 5.93	RG3	RG3

• Hazard zone

The below figure describes the radiation zone (hazard zone) of light emitted by the projector that is classified as Risk Group 3 (RG3) of IEC/EN 62471-5:2015.

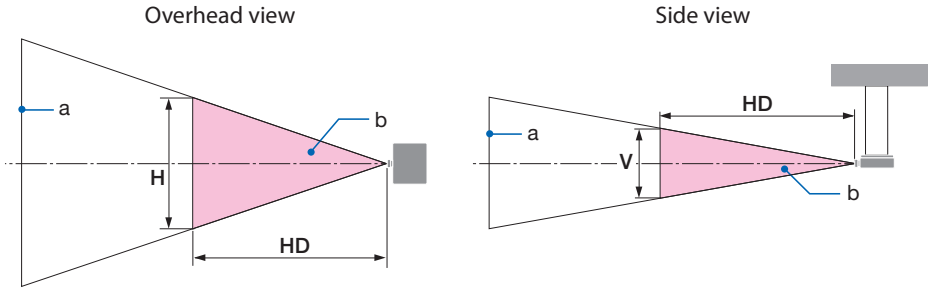

a: Screen / b: Hazard zone

A104U-W/A104U-B

Lens	Throw ratio	Hazard zone (m)		
		HD	H	V
XP-43ZL/ NP43ZL	2.99 (Wide)	-	-	-
	3.90 (Middle)	1.00	0.31	0.19
	5.93 (Tele)	1.32	0.19	0.12

A824U-W/A824U-B

Lens	Throw ratio	Hazard zone (m)		
		HD	H	V
XP-43ZL/ NP43ZL	2.99 (Wide)	-	-	-
	5.60 (Middle)	1.00	0.25	0.17
	5.93 (Tele)	1.32	0.23	1.15

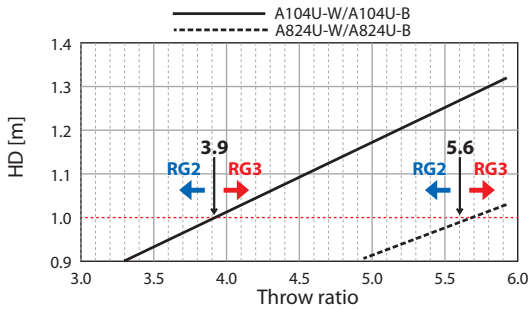

Calculation of the throw ratio

Throw ratio = L: Throw distance (m) / W: Screen width (m)

For throw distances and screen widths, refer to "Lens types and throw distance". (→ page 165, 166)

• About the precautionary zone

By providing a precautionary zone or physical barriers, it must prevent human eyes from entering the hazard zone.

When the manager of the projector (operator) cannot prevent spectators from entering the hazard zone such as in public facilities, it is required to secure a space of 1 m or more from the hazard zone as “the precautionary zone” for the safety of the spectators. When installing the projector overhead, it is required that the distance between the floor and the hazard zone be at least 3 m in the vertical direction.

In the United States, provide a horizontal distance of 2.5 meters from the hazard zone.

When install the projector overhead, provide a vertical distance of 3 meters from the floor to the hazard zone.

• Installation example considering the precautionary zone

① Floor or desktop installation example

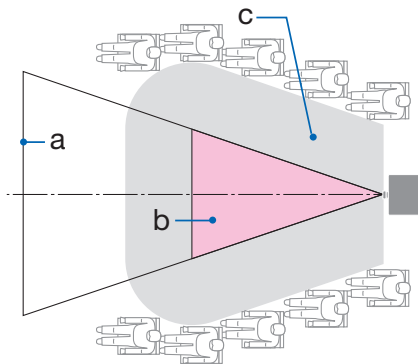

② Ceiling installation example

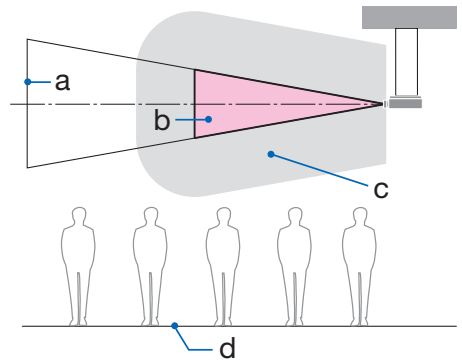

a: Screen / b: Hazard zone / c: Precautionary zone / d: floor

 <p>CAUTION</p>	<p>If it is expected that spectators will intrude into the hazard zone when installed on the ceiling, it is necessary to prevent spectators from entering that area.</p>
---	--

③ **Example of downward projection installed on the ceiling**

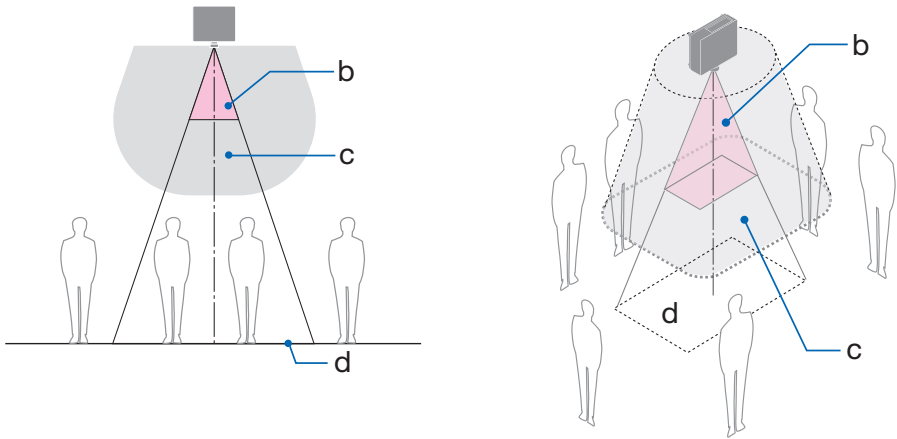

a: Screen / b: Hazard zone / c: Precautionary zone / d: floor

 <p>CAUTION</p>	<p>If the precautionary zone between the floor and the hazard zone cannot be secured, it is necessary to prevent spectators from entering the area around the screen as shown in the figure on the right.</p>
---	---

* If using lens shift, please consider the shift of projected image according to the volume of lens shift. Installation example considering the precautionary zone



Please follow all safety precautions.

Installing the projector

- When planning the layout of the projector, make sure to follow the safety measures listed in the installation manual.
- In order to avoid danger, either install the device within easy reach of a wall outlet or provide a device like a breaker to disconnect power to the projector in emergency.
- Take safety measures to prevent human eyes from entering the hazard zone.
- Select an appropriate lens for the installation location and secure the safety zone set for each lens.
Ensure that appropriate safety measures have been taken when operating the projector, adjusting the light, etc.
- Check whether the appropriate safety zone for the installed lens has been adequately secured. Periodically check the zone and maintain a record of verifications.

The installer or dealer must instruct the manager (operator) of the projector of the following:

- Educate the manager of the projector (operator) about safety before operating the projector.
- Instruct the manager of the projector (operator) to perform inspections (including safety checks on light emitted by the projector) before powering the projector on.
- Instruct the manager of the projector (operator) to be able to control the projector whenever the projector is powered on in case of an emergency.
- Instruct the manager of the projector (operator) to keep the installation manual, user's manual and inspection records in an easy-to-reach place.
- Instruct them to determine whether the projector conforms to the standards of each country and region.

Notes on installation and maintenance

Do not install or store in such places as those described below.

- Locations that amplify vibrations and impacts
If installed in places where the vibrations from power sources and the like are conveyed, or in vehicles or on vessels, etc. the projector could be affected by vibrations or shocks that may damage internal parts and lead to malfunction.
- Close to high voltage power lines and power sources
It could disrupt the unit.
- Places where strong magnetic fields are generated
Doing so could lead to malfunction.
- Outdoors and places with humid or dust
Places exposed to oil smoke or steam
Places where corrosive gases are generated
Attached substances such as oil, chemicals and moisture may cause deformation or cracks of the cabinet, corrosion of the metal parts, or malfunction.

Precautions when installing on the ceiling

1. To prevent the projector from falling, install it on the ceiling in a way with sufficient strength to withstand the combined weight of the projector and the ceiling mount unit for an extended period of time.
2. When installing the projector on the ceiling, be sure to do so correctly in accordance with the installation manual for the Ceiling Mount Unit. Be sure to use the fixed metal fittings and to tighten the screws securely.
3. To prevent the projector from falling, use fall prevention wires.
 - Use commercially available metal fittings to join the robust part of a building or construction and the security bar of the projector with the fall prevention wires.
 - Use commercially available metal fittings and fall prevention wires that have sufficient strength to withstand the combined weight of the projector and the ceiling mount unit.
 - Slightly slack off the fall prevention wires so as not to put a load on the projector.
 - Refer to the “Part Names of the Projector” for the location of the security bar. (→ page 6)

Securing personal information

Personally identifiable information, such as IP addresses, may be saved on the projector.

Before transferring or disposing of the projector, clear this data by performing [INITIALIZE PROJECTOR] on the on-screen menu.

Cautions for ensuring the projector's performance

- If intense light like laser beams enters from the lens, it could lead to malfunction.
- Consult your dealer before using in places where much cigarette smoke or dust is present.
- When the same still image is projected for a long period of time with a computer, etc. the pattern of the image may remain on the screen after the projection is stopped, but it will disappear after a while. This happens due to the properties of liquid crystal panels, and is not a malfunction. We recommend using a screensaver on the computer side.
- When the projector is used at high altitudes (places where the atmospheric pressure is low), it may be necessary to replace the optical parts sooner than usual.
- About moving the projector
 - Detach the lens unit once, and be sure to attach the lens cap so as not to scratch the lens. Also, attach a dust protective cap to the projector.
 - Do not subject the projector to vibrations or strong shocks.
The projector could be damaged otherwise.
- Do not use the tilt feet for purposes other than adjusting the projector's tilt.
Improper handling, such as carrying the projector by the tilt feet or using it leaned against a wall, could lead to malfunction.
- The projector does not support stack installation. Do not stack projectors directly on top of each other. Failure to do so may cause damage or failure.
- Do not touch the surface of the projection lens with bare hands.
Fingerprints or dirt on the surface of the projection lens will be enlarged and projected on the screen. Do not touch the surface of the projection lens.
- Do not unplug the power cord from the projector or the power outlet while projecting. Doing so could cause deterioration of the projector's AC IN terminal or power plug contact. To interrupt the AC power supply while images are being projected, use a breaker, etc.
- About handling of the remote control
 - The remote control will not work if the projector's remote signal sensor or the remote control's signal transmitter is exposed to strong light or if there are obstacles between them that obstruct the signals.
 - Operate the remote control from within 20 meters from the projector, pointing it at the projector's remote signal sensor.
 - Do not drop the remote control or handle it improperly.
 - Do not let water or other liquids get on the remote control. Should the remote control get wet, wipe it off immediately.
 - Avoid using in hot and humid places as far as possible.
- Take measures to prevent external light from shining on the screen.
Make sure only the light from the projector shines on the screen. The less external light on the screen, the higher the contrast and the more beautiful the images.
- About screens
Images will not be clear if there is dirt, scratches, discoloration, etc. on your screen. Handle the screen with care, protecting it from volatile substances, scratches and dirt.

Precautions when installing the projector at an angle



This projector can be installed universally in every angle. When installing the projector at the angles shown below, the separately sold cable cover is required to be attached to the projector. For tilted installation of the projector, use a metal fitting with sufficient strength to prevent it from falling.

Model name of cable cover

XP-13CV-W for A104U-W/A824U-W

XP-13CV-B for A104U-B/A824U-B

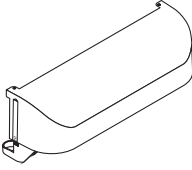
Two covers are packaged with the cable cover XP-13CV-W and XP-13CV-B.

Option cover A: for attaching to the connection terminal area	
Option cover B: for attaching to the exhaust vent	

 WARNING

- Using without the option cover violates safety regulations. Also, powering the projector on without the option cover installed could result in a fire.

The drawings below show the installation angle required to attach the option cover A and B respectively.

- Both option cover A and B may need to be attached depending on the installation position of the projector.
- Whether the option cover needs to be attached in the current installation position can be checked on the [INFO.] screen of the on-screen menu (→ pages 144).

Installation angles required to attach the option cover A

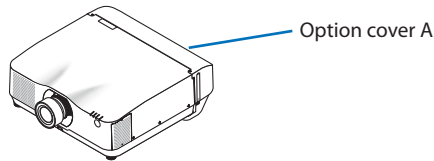

In the direction of back and forth

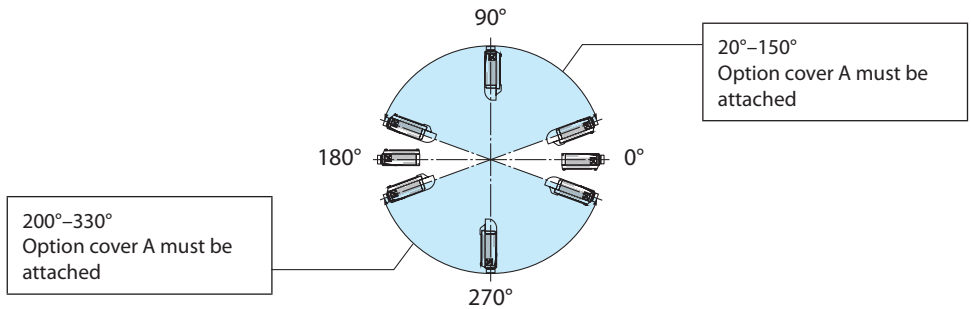

In the direction of left and right

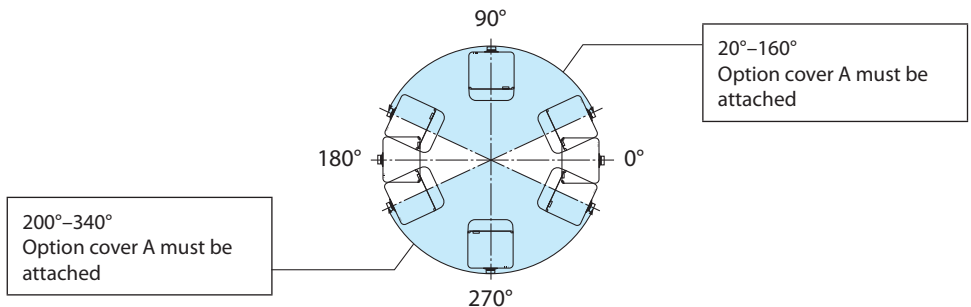

NOTE:

- The drawings show the image of installation angle as a reference. They are slightly different from the actual one.

Installation angles required to attach the option cover B

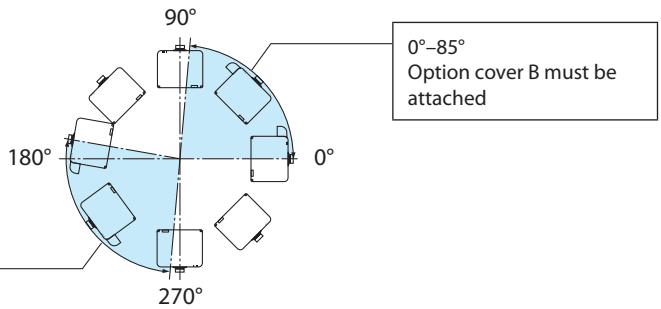
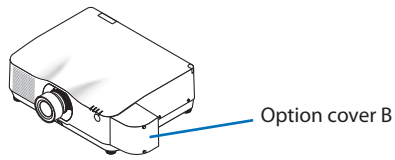

NOTE:

- The drawings show the image of installation angle as a reference. They are slightly different from the actual one.

Clearance for Installing the Projector

- When installing the projector, keep sufficient space around it, as described below. If not, the hot exhaust emitted from the projector may be taken back in. Also, make sure no wind from an air-conditioner hits the projector. The projector's heat control system may detect an abnormality (temperature error) and automatically shut off the power.

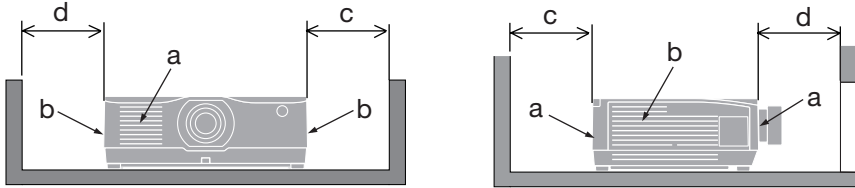

a: Intake vent / b: Exhaust vent / c: 20 cm/8" or greater / d: 30 cm/12" or greater

NOTE:

- In the above figure, it is assumed that there is sufficient space above the projector.
 - If the option cover is installed, leave a space of 20 cm/8" between the projector and the option cover.
-
- When using multiple projectors together for multi-screen projection, provide sufficient space around the projectors for air intake and exhaust. When the intake and exhaust vents are obstructed, the temperature inside the projector will rise and this may result in a malfunction.

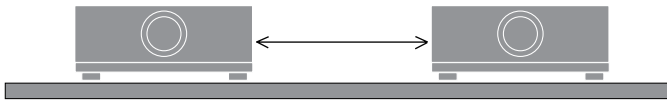

About Copyright of original projected pictures:

Please note that using this projector for the purpose of commercial gain or the attraction of public attention in a venue such as a coffee shop or hotel and employing compression or expansion of the screen image with the following functions may raise concern about the infringement of copyrights which are protected by copyright law.

[ASPECT RATIO], [KEYSTONE], Magnifying feature and other similar features.

[AUTO POWER OFF] Function

The factory default setting for [AUTO POWER OFF] is 15 minutes. If no input signal is received and no operation is performed on the projector during 15 minutes, the projector is automatically powered off for saving the power consumption. In order to control the projector by an external device, set the [AUTO POWER OFF] to [OFF]. Please refer page 142 for details.

REGISTER YOUR PROJECTOR! (for residents in the United States and Mexico)

Please take time to register your new projector. This will activate your limited parts and labor warranty and InstaCare service program.

Visit our website at <https://www.sharpnecdisplays.us/product-registration> and submit your completed form online.

Upon receipt, we will send a confirmation letter with all the details you will need to take advantage of fast, reliable warranty and service programs from the industry leader, Sharp Imaging and Information Company of America.

Registration Information and Software License

- ProAssist, and Virtual Remote are trademarks or registered trademarks of Sharp NEC Display Solutions, Ltd. in Japan, in the United State and other countries.
- The terms HDMI, HDMI High-Definition Multimedia Interface, HDMI Trade dress and the HDMI Logos are trademarks or registered trademarks of HDMI Licensing Administrator, Inc.
- HDBaseT™ and the HDBaseT Alliance logo are trademarks of the HDBaseT Alliance.
- Trademark PJLink is a trademark applied for trademark rights in Japan, the United States of America and other countries and areas.
- Blu-ray is a trademark of Blu-ray Disc Association.
- CRESTRON and CRESTRON ROOMVIEW are trademarks or registered trademarks of Crestron Electronics, Inc. in the United States and other countries.
- Extron and XTP are registered trademarks of RGB Systems, Inc. in the United States.
- Ethernet is either a registered trademark or trademark of FUJIFILM Business Innovation Corp.
- Art-Net™ Designed by and Copyright Artistic Licence Holdings Ltd.
- Other product and company names mentioned in this user's manual may be the trademarks or registered trademarks of their respective holders.
- Virtual Remote Tool uses WinI2C/DDC library, © Nicomsoft Ltd.

1. Check the product overview, supplied items and part names

1-1. Introduction to the Projector

This section introduces you to your new projector and describes the features and controls.

- **Liquid crystal type high brightness/high resolution projector**

This projector has a display resolution of 1920 dots × 1200 lines (WUXGA) and an aspect ratio of 16:10.

Model	Brightness
A104U-W/A104U-B	10000 lm (Center 10500 lm)
A824U-W/A824U-B	8200 lm (Center 8600 lm)

- **A long-life laser diode is equipped in the light module**

The laser light source has a long service life, so replacement, adjustment, and other maintenance should not be necessary for an extended period of time.

- **A proprietary sealed structure that achieves highly dust-proof performance**

Due to its excellent dust-proof performance, the projector is not equipped with a filter. Filter replacement is therefore unnecessary.

- **Wide range of optional lenses selectable according to the place of installation**

This projector supports 5 types of optional lenses, providing a selection of lenses adapted to a variety of places of installation and projection methods.

Note that no lens is mounted upon shipment from the factory. Please purchase optional lenses separately.

- **360 degree free projection**

The projector is equipped with a “tilt-free” function for 360° projection vertically and a “roll-free” function for 360° projection horizontally.

Note, however, that the separately sold cable cover is required to be attached to the projector depending on the installation angle of the projector.

- **High quality pictures using Cinema Quality Picture technology**

The projector displays extremely high quality pictures by combining the technology used to develop digital cinema projectors with the image processing technologies we have amassed over our countless years of developing projectors.

- **Multi-screen projection using multiple projectors**

This projector equips the HDBaseT IN and HDBaseT OUT ports. Using a LAN cable, control signals can be transmitted in addition to the audio/visual signals (up to four devices can be connected).

The edge blending function creates smooth borders when using multiple units to project a single image.

1. Check the product overview, supplied items and part names

- **Simultaneous display of 2 images (PIP/PICTURE BY PICTURE)**

Two images can be projected simultaneously with a single projector.

There are two types of layouts for the two images: [PIP] in which a sub-picture is displayed on the main picture, and [PICTURE BY PICTURE] in which the main and sub pictures are displayed next to each other.

- **Seamless switch function for smoother screen changes when switching the signal**

When the input connector is switched, the image displayed before switching is held so that that the new image can be switched to without a break due to absence of a signal.

- **Supports wired LAN**

Equips the LAN and HDBaseT ports. Utilizing a wired LAN connected with these ports, it enables to control the projector by a computer.

- **Convenient software applications**

Compatible with our software applications (NaViSet Administrator 2, ProAssist, Virtual Remote Tool, etc.). The projector can be controlled from a computer connected via a wired LAN.

- NaViSet Administrator 2

You can monitor the status of the projector and control a variety of functions.

- ProAssist

Necessary adjustments can be made smoothly for multi-screen projection.

- Virtual Remote Tool

A virtual remote control is displayed on the computer screen to perform simple controls such as turning the projector on/off, switching signals, etc.

Please visit our website for downloading each software.

URL: <https://www.sharp-nec-displays.com/dl/en/index.html>

- **CRESTRON ROOMVIEW and Extron XTP compatibility**

The projector supports CRESTRON ROOMVIEW and Extron XTP, allowing multiple devices connected in the network to be managed and controlled from a computer. Moreover, it enables to output and control image via an Extron XTP transmitter connected with the projector.

- **Energy-saving design with a standby power consumption of 0.20 W (100-130 V AC) / 0.26 W (200-240 V AC)**

Selecting [ON] for [POWER-SAVING] from the menu can put the projector in power-saving mode.

When network is enabled: 0.7 W (100-130 V AC)/0.8 W (200-240 V AC)

When the network is disabled: 0.20 W (100-130 V AC)/0.26 W (200-240 V AC)

1. Check the product overview, supplied items and part names

- **[LIGHT MODE] and “Carbon Meter” display**

Three [LIGHT MODE] options can be selected according to the purpose of use. [LIGHT ADJUST] can also be used to reduce output power and control energy consumption. The energy-saving effect from that time will be factored into the amount of reduced CO₂ emissions and displayed in the confirmation message when turning the power off as well as the [INFO.] area in the on-screen menu (CARBON METER)

1. Check the product overview, supplied items and part names

1-2. What's in the Box?

Make sure your box contains everything listed. If any pieces are missing, contact your dealer. Please save the original box and packing materials if you ever need to ship your projector.

Projector

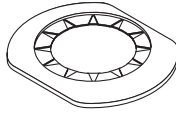
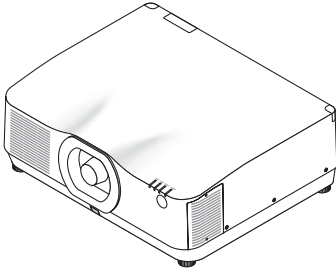

Dust cap for lens

* The projector is shipped without a lens. For the types of lens and throw distances, see page 164.

Lens mask

Lens theft prevention screw

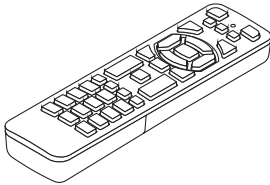

Remote control

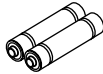

AAA alkaline batteries (× 2)

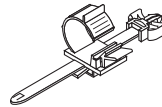

Power cord stopper

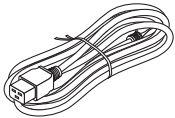

Power cord

See page ix.

Plug type	
For North America	For Europe/Asia

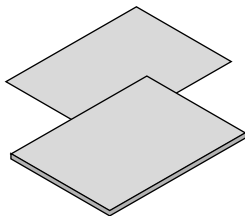

- **Important Information**
- **Safety Cautions (For Europe)**
- **Quick Setup Guide**
- **Security Sticker**

(Use this sticker when security password is set on.)

For USA only

Limited warranty

For customers in Europe

You will find our current valid Guarantee Policy on our website:

<https://www.sharpnecdiseplays.eu>

1-3. Part Names of the Projector

Front

The lens is sold separately. The description below is for when the XP-41ZL lens is mounted.

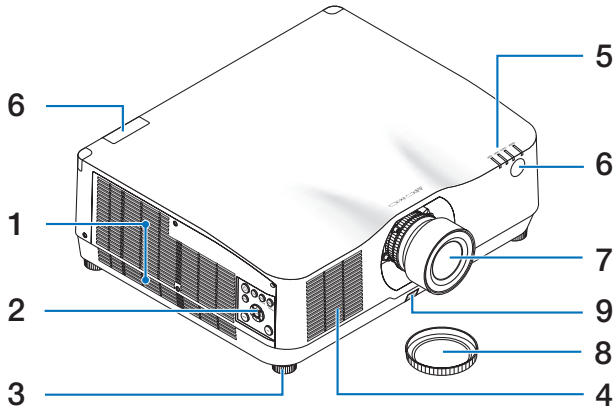

1. Exhaust vent

Heated air is exhausted from here.

2. Controls

The projector's power can be turned ON/OFF, and the signal for the projected image can be switched here.

3. Adjustable Tilt Foot

Rotate the tilt feet to adjust the left/right orientation.

4. Intake vent

Takes in outside air to cool the unit.

5. Indicator Section

The indicator light turns on or blinks to relay the status of the projector (Power ON/Standby/etc.)

(→ page 7, 182)

6. Remote Sensor

This part receives signals from the remote control. There are two locations on the front and back of the projector.

7. Lens

Images are projected from here. (Lens unit sold separately.)

8. Lens Cap

(The optional lens is shipped with the lens cap.)

9. Lens Release Button

Use this to remove the lens unit.

1. Check the product overview, supplied items and part names

Rear

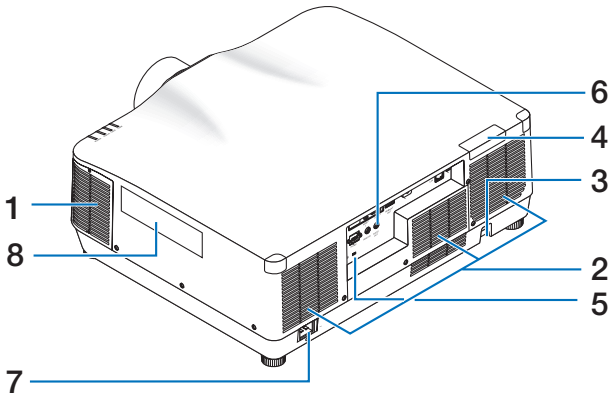

1. Exhaust vent

Heated air is exhausted from here.

2. Intake vent

Takes in outside air to cool the unit.

3. Security Bar

Attach an anti-theft device. The security bar accepts security wires or chains up to 0.18 inch/4.6 mm in diameter.

4. Remote Sensor

This part receives signals from the remote control. There are two locations on the front and back of the projector.

5. Security Slot (🔒)*

This is used when attaching an anti-theft cable.

6. Terminals

Connect the cables for the various audio and video signals.

7. AC IN Terminal

Connect the supplied power cord's three-pin plug here, and plug the other end into an active wall outlet.

8. Label

* Security and theft protection lock compatible with Kensington security cables/equipment. For products, visit Kensington's website.

Controls/Indicators

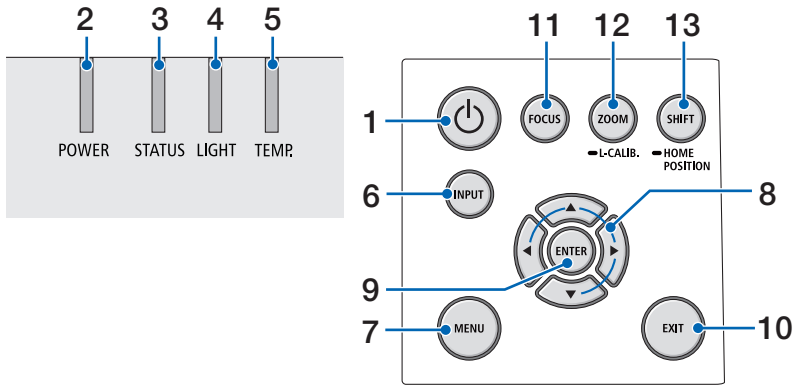

1. (POWER) Button

Switches between projector's power on and standby.

When turning off the power (standby), pressing the button once will bring up a confirmation message on the screen, so press the button one more time.

2. POWER Indicator

Indicates the projector's power state. The indicator lights up in blue when the power is on. Depending on the state of power, it will light up or blink in either green or orange when power is off. Refer to the "Indicator Message" section for details.

(→ page 182)

3. STATUS Indicator

This lights up or blinks when an operation button is pressed while the unit is in key lock mode, while the lens is calibrating, etc. Refer to the "Indicator Message" section for details.

(→ page 182)

4. LIGHT Indicator

Indicates the state of the light source.

5. TEMP. Indicator

Indicates high temperatures around the projector.



6. INPUT Button

Selects the input signal. Pressing it quickly will display the input selection screen. Pressing it for one second or longer will begin a series of automatic checks in the order of HDMI1 → HDMI2 → HDBaseT, and if an input signal is detected then that signal will be projected.

7. MENU Button

Displays the on-screen menu for various settings and adjustments.

8. / Volume Buttons

- When the on-screen menu is displayed, use the  buttons to select the item that you wish to set or adjust.
- Changes the pattern when the test pattern is displayed.
- When the on-screen menu is not displayed, use the  buttons to adjust the sound output from the projector.

1. Check the product overview, supplied items and part names

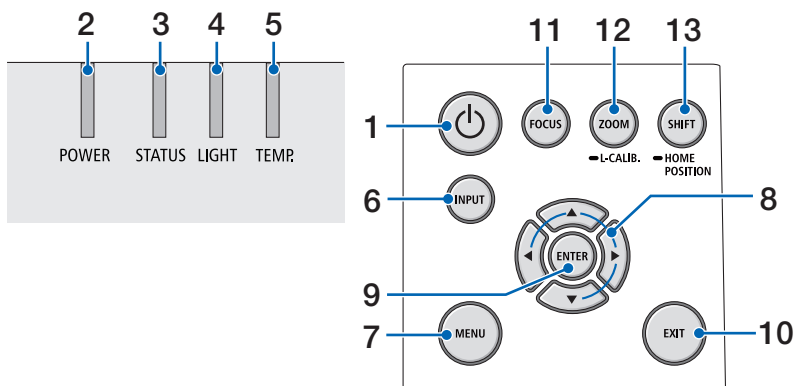

9. ENTER Button

Moves to the next menu when the on-screen menu is displayed. Confirms the item when the confirmation message is displayed.

10. EXIT Button

Returns to the menu on the previous level when the on-screen menu is displayed. Closes the menu when a cursor appears in the main menu. Cancels the operation when the confirmation message is displayed.

11. FOCUS Button

Open the focus adjustment screen and focus the projected image.

12. ZOOM/L-CALIB. Button

- Short press to open the zoom adjustment screen. Finely adjust the size of the projected image.
- Long press (two seconds or longer) to correct the adjustment range of the attached lens unit (calibration).

13. SHIFT/HOME POSITION Button

- Short press to display the lens shift screen. Adjust them using the ▼▲◀▶ buttons.
- Long press (2 seconds or longer) to return the lens shift adjustment to its initial position.

1. Check the product overview, supplied items and part names

Terminal Panel Features

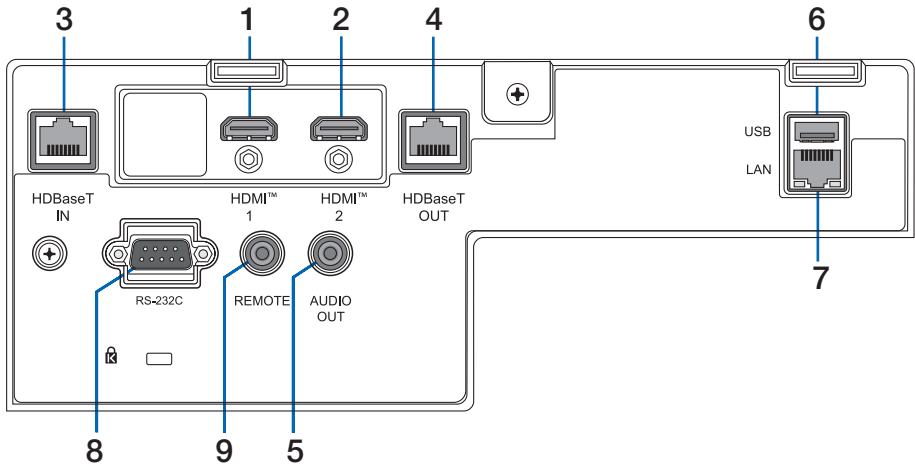

1. HDMI 1 Terminal (Type A)

Connects to the output terminals of a computer, blu-ray player, etc.

2. HDMI 2 Terminal (Type A)

Connects to the output terminals of a computer, blu-ray player, etc.

3. HDBaseT IN Port (RJ-45)

Connects to a commercially available HD-BaseT compatible transmission devices. Also used when connecting multiple projectors in daisy chaining.

4. HDBaseT OUT Port (RJ-45)

Outputs incoming signals from the HDMI 1 terminal, HDMI 2 terminal, and HDBaseT IN Port.

5. AUDIO OUT Mini Jack (Stereo Mini)

Outputs the audio signal corresponding to the image projected from the projector. The output volume can be adjusted using the ◀ / ▶ buttons.

6. USB Port (Type A)

Connect a commercially available USB mouse and use it to navigate the menu.

NOTE:

- Not guarantee the performance of all USB mouse available on the market.

7. LAN Port (RJ-45)

Connects the unit to a wired LAN.

8. RS-232C Port (D-Sub 9 Pin)

Use this port to connect a PC or control system. This enables you to control the projector using serial communication protocol. The reverse type cable (null modem cable) (not supplied) should be used for RS-232C control.

1. Check the product overview, supplied items and part names

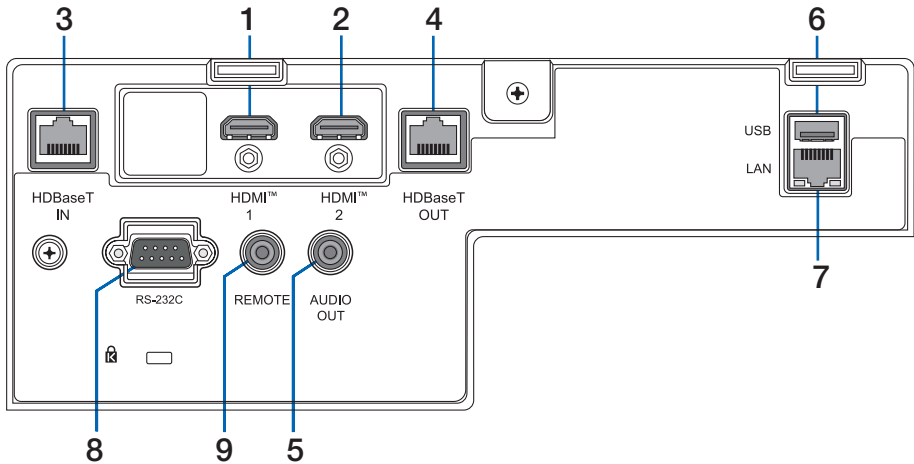

9. REMOTE Terminal (Stereo Mini)

Use this terminal for wired remote control of the projector.

NOTE:

- When a remote control cable is connected to the REMOTE terminal, infrared remote control operations cannot be performed.
- When [HDBaseT] is selected in the [REMOTE SENSOR] and the projector is connected to a commercially-available transmission device that supports HDBaseT, remote control operations in infra-red cannot be carried out if transmission of remote control signals has been set up in the transmission device. However, remote control using infrared rays can be carried out when the power supply of the transmission device is switched off.

1. Check the product overview, supplied items and part names

1-4. Part Names of the Remote Control

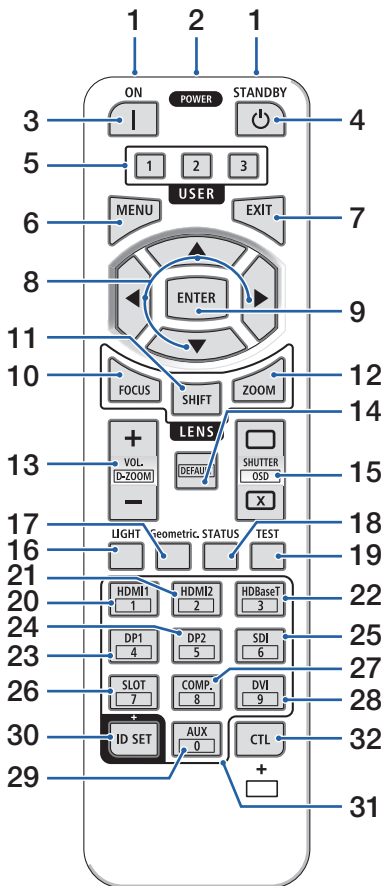

1. Infrared Transmitter

Remote control signals are sent via infrared signal. Point the remote control at the remote control receiver on the projector.

2. Remote Jack

Connect a commercially available remote cable here for wired operation.

3. POWER ON Button (|)

Turns power ON when in sleep or standby mode.

4. POWER STANDBY Button (⏻)

Pressing the button once will display the shutdown confirmation message. Press the POWER STANDBY (or ENTER) button once more to power down the projector.

5. USER 1/2/3 Button

The following 14 functions can be selected and set. When the character input screen is displayed, use this to switch the character keyboard, insert a space, and erase characters.

6. MENU Button

Displays the on-screen menu for various settings and adjustments.

7. EXIT Button

Returns to the menu on the previous level when the on-screen menu is displayed. Closes the menu when a cursor appears in the main menu. Cancels the operation when the confirmation message is displayed.

8. ▲▼◀▶ Button

- When the on-screen menu is displayed, use the ▲▼◀▶ buttons to select the item that you wish to set or adjust.
- Changes the pattern when the test pattern is displayed.

1. Check the product overview, supplied items and part names

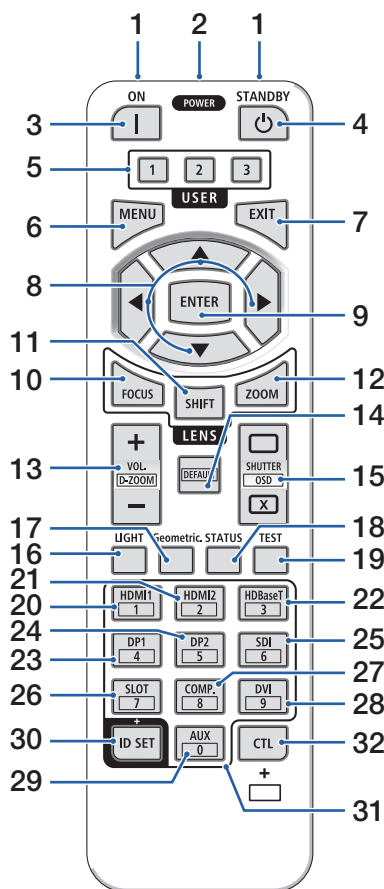

9. ENTER Button

Moves to the next menu when the on-screen menu is displayed. Confirms the item when the confirmation message is displayed.

10. FOCUS Button

Opens the focus adjustment screen. Adjust the focus (of the lens) with the ◀ / ▶ buttons.

11. SHIFT Button

The lens shift adjustment screen will be displayed. Use the ▼▲◀▶ buttons to adjust the lens position.

12. ZOOM Button

Opens the zoom adjustment screen. Adjust zoom with the ◀ / ▶ buttons.

13. VOL./D-ZOOM (+)(-) Button

Adjusts the volume level of the audio output terminals. Simultaneously pressing the CTL button will expand or shrink the image (return to the original state).

14. DEFAULT Button

Simultaneously pressing the CTL button when the on-screen menu is displayed will reset the adjustment values.

This only works for the items with DEFAULT displayed in the Operation Guide.

15. SHUTTER/OSD OPEN (□)/CLOSE (X) Button

Press the CLOSE button to turn off the light source and temporarily stop projection. Press the OPEN button to resume. Simultaneously press the CTL and CLOSE buttons to close the on-screen display (On-Screen Mute). Simultaneously press the CTL and OPEN buttons to go back.

16. LIGHT Button

Displays the light mode screen.

NOTE:

- The settings in [ADJUST] → [PICTURE] → [MODE] change the screen displayed.

1. Check the product overview, supplied items and part names

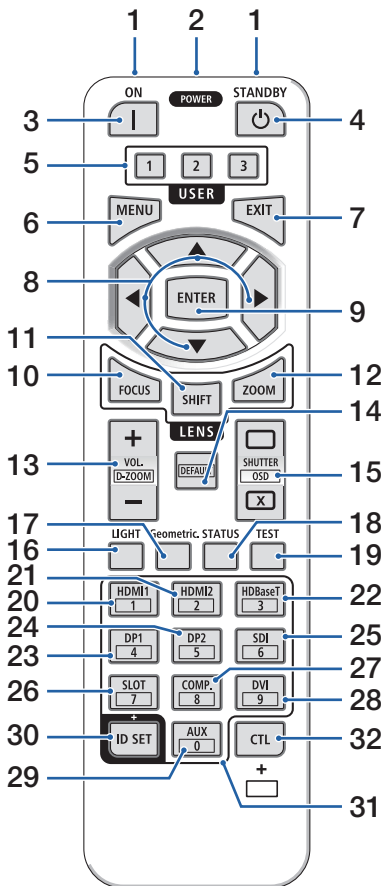

17. Geometric. Button

Displays [GEOMETRIC CORRECTION] from the on-screen menu. Use it to adjust distortions in projected images.

18. STATUS Button

Displays [USAGE TIME] of [INFO.] from the on-screen menu.

19. TEST Button

Projects a test pattern.

20. HDMI1 Button

Selects the HDMI 1put.

21. HDMI2 Button

Selects the HDMI 2put.

22. HDBaseT Button

Selects the HDBaseT input.

23. DP1 Button

(Not available on this series of projectors.)

24. DP2 Button

(Not available on this series of projectors.)

25. SDI Button

(Not available on this series of projectors.)

26. SLOT Button

(Not available on this series of projectors.)

27. COMP. Button

(Not available on this series of projectors.)

28. DVI Button

(Not available on this series of projectors.)

29. AUX Button

(Not available on this series of projectors. For future expansion)

1. Check the product overview, supplied items and part names

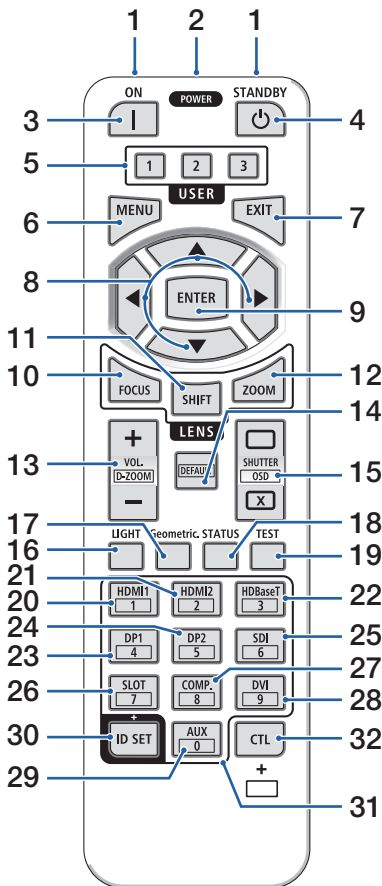

30. ID SET Button

Used to set the control ID when performing individual operations on multiple projectors using the remote control. Also used to toggle the character keyboard when the character input screen is displayed.

31. Numeric Keypad Button

Used to input the control ID when performing individual operations on multiple projectors using the remote control (set the control ID). Pressing the 0 button while holding down the ID SET button will remove any control ID settings. Used to enter alphanumeric characters directly when the character input screen is displayed.

32. CTL Button

This is a multipurpose button for combined use with other buttons.

Battery Installation

1. Press the catch and remove the battery cover.

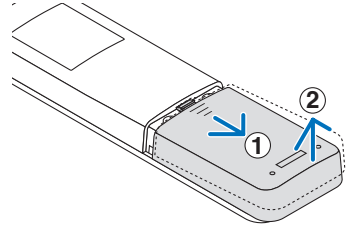

2. Install AAA alkaline batteries. Ensure that you have the batteries' polarity (+/-) aligned correctly.

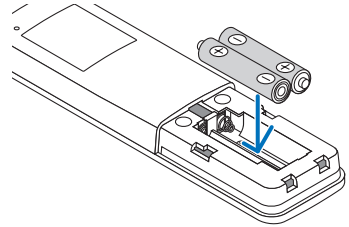

3. Slip the cover back over the batteries until it snaps into place.

NOTE:

- Do not mix different types of batteries or new and old batteries.
- When replacing the batteries, purchase 2 of the same type of AAA alkaline batteries.

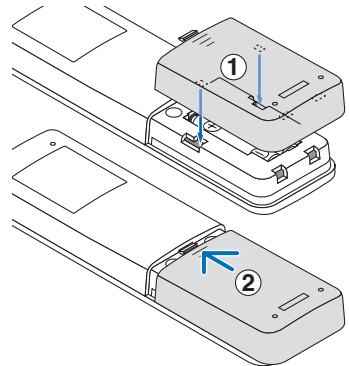

Remote Control Precautions

- Handle the remote control carefully.
- If the remote control gets wet, wipe it dry immediately.
- Avoid excessive heat and humidity.
- Do not short, heat, or take apart batteries.
- Do not throw batteries into fire.
- If you will not be using the remote control for a long time, remove the batteries.
- Ensure that you have the batteries' polarity (+/-) aligned correctly.
- Do not use new and old batteries together, or use different types of batteries together.
- Dispose of used batteries according to your local regulations.
- Please note that if multiple projectors are installed nearby, other projectors may unintentionally light up when you turn on the power using the remote control.

1. Check the product overview, supplied items and part names

Operating Range for Wireless Remote Control

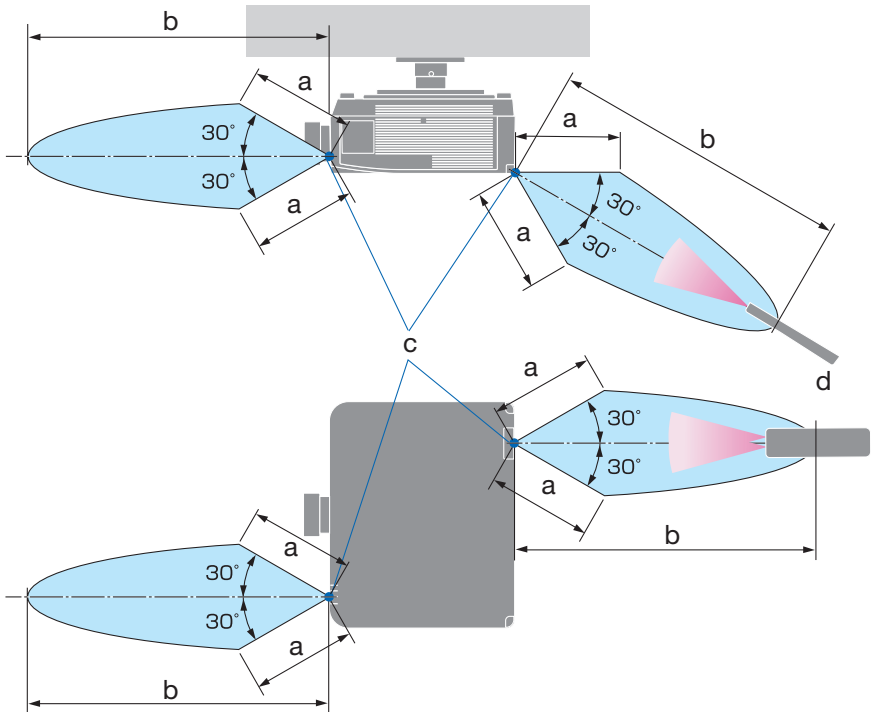

a: 7 m/276" / b: 20 m/787" / c: Remote sensor on projector cabinet / d: Remote control

- The projector will not respond if there are objects between the remote control and the sensor, or if strong light falls on the sensor. Weak batteries will also prevent the remote control from properly operating the projector.

1. Check the product overview, supplied items and part names

Using the Remote Control in Wired Operation

Connect one end of the remote cable to the REMOTE terminal and the other end to the remote jack on the remote control.

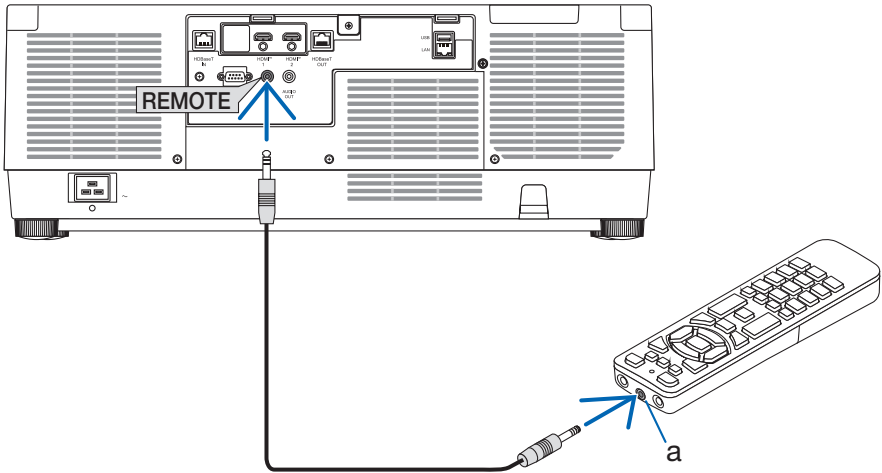

a: Remote jack

NOTE:

- When a remote cable is inserted into the REMOTE terminal, the remote control does not work for infrared wireless communication.
 - Power will not be supplied to the remote control by the projector via the REMOTE jack. Battery is needed when the remote control is used in wired operation.
-

2. Projecting an Image (Basic Operation)

This section describes how to turn on the projector and to project a picture onto the screen.

2-1. Flow of Projecting an Image

Step 1

- **Connecting your computer / Connecting the power cord** (→ [page 19](#))



Step 2

- **Turning on the projector** (→ [page 22](#))



Step 3

- **Selecting a source** (→ [page 25](#))



Step 4

- **Adjusting the picture size and position** (→ [page 27](#))



Step 5

- **Adjusting a picture and sound** (→ [page 35](#))



Step 6

- **Making a presentation**



Step 7

- **Turning off the projector** (→ [page 36](#))



Step 8

- **After use** (→ [page 37](#))

2-2. Connecting Your Computer/Connecting the Power Cord

1. Connect your computer to the projector.

This section will show you a basic connection to a computer.

Connect a commercially available HDMI cable between the computer's HDMI output connector and the projector's HDMI 1 or HDMI 2 connector.

2. Connect the supplied power cord to the projector.

First connect the supplied power cord's three-pin plug to the AC IN terminal of the projector, and then connect another plug of the supplied power cord directly in the wall outlet. Do not use any plug converter.



CAUTION:

- This equipment is designed to be used in the condition of the power cord connected to earth. If the power cord is not connected to the earth, it may cause electric shock. Please make sure the power cord is connected to the wall outlet directly and earthed properly. Do not use a 2-core plug converter adapter.
- Be sure to connect the projector and the computer (signal source) to the same earth point. If the projector and the computer (signal source) will be connected to different earth points, fluctuations in the earth potential may cause fire or smoke.
- To prevent the power cord from coming loose, make sure that all the prongs of the power cord plug are fully inserted into the AC IN terminal of the projector before using the power cord stopper. A loose contact of the power cord may cause a fire or electric shock.

Upon connecting the power cable, the POWER indicator of the projector will light.

2. Projecting an Image (Basic Operation)

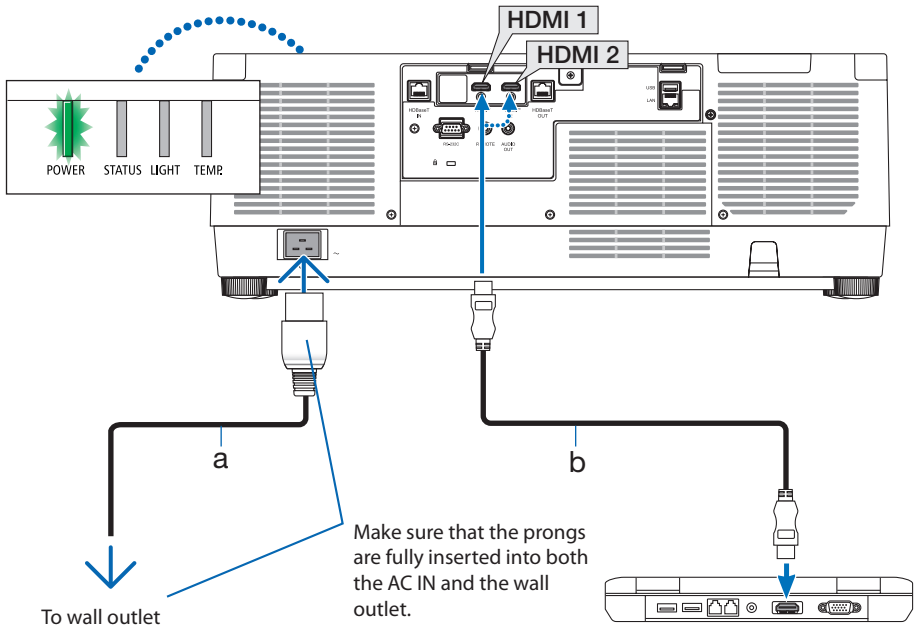

a: Power cord (supplied) / b: HDMI cable (not supplied)

- Use a Premium High Speed HDMI Cable.

CAUTION:

Parts of the projector may become temporarily heated if the projector is turned off with the POWER button or if the AC power supply is disconnected during normal projector operation. Use caution when picking up the projector.

Using the power cord stopper

To prevent the power cord from accidentally removing from the AC IN of the projector, use the power cord stopper.

NOTE:

- If you pull on the power supply cord while the connector is fixed, the main unit may fall down and be damaged

- ① With the clamber facing the power supply cord, align the tip of the power supply cord stopper with the hole below the AC IN terminal and push it in.
- ② Pass the power supply cord through the clamber and press the clamber to fix it.
- ③ Slide the clamber until the base of the power plug.

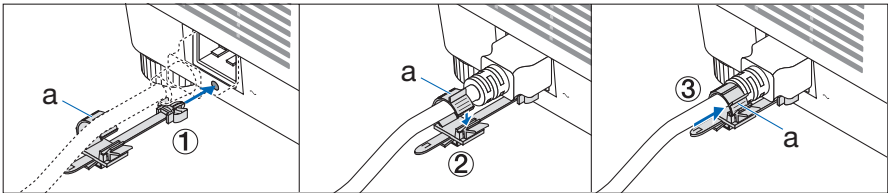

a: Clamber

2-3. Turning on the Projector

WARNING

The projector produces a strong light. When turning on the power, operate from the side or rear of the projector (outside the hazard zone). Also, when turning on the power, make sure no one within the projection range is looking at the lens.

1. Remove the lens cap.

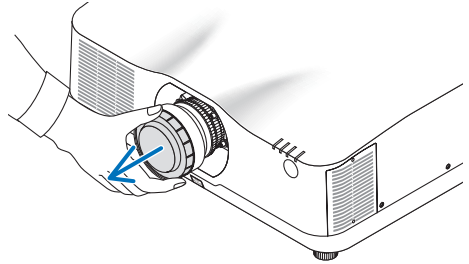

2. Press the (POWER) button on the projector cabinet or the POWER ON button on the remote control.

The POWER indicator lit in green will start to blink in blue. After that, the image will be projected onto the screen.

TIP:

- When the message "PROJECTOR IS LOCKED! ENTER YOUR PASSWORD." is displayed, it means that the [START-UP LOCK] feature is turned on.
-

After you turn on your projector, ensure that the computer or video source is turned on.

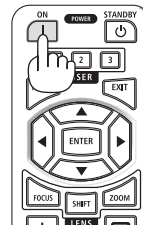

NOTE:

- A blue screen (blue background) is displayed when no signal is being input (by factory default menu settings).
-

Performing Lens Calibration

After mounting the separately available lens unit or replacing a lens unit, perform [LENS CALIBRATION] by holding to press ZOOM/L-CALIB. button on the cabinet over two seconds.

Calibration corrects the adjustable zoom, shift, and focus range. If calibration is not performed, you may not be able to get the best focus and zoom even if you adjust the focus and zoom for the lens.

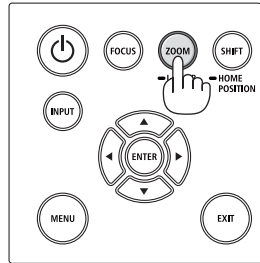

Note on Startup screen

When you first turn on the projector, you will get the Startup menu. This menu gives you the opportunity to select one of the 30 menu languages.

To select a menu language, follow these steps:

1. Use the ▲, ▼, ◀ or ▶ button to select one of the 30 languages from the menu.

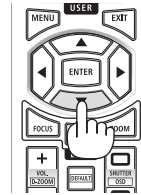
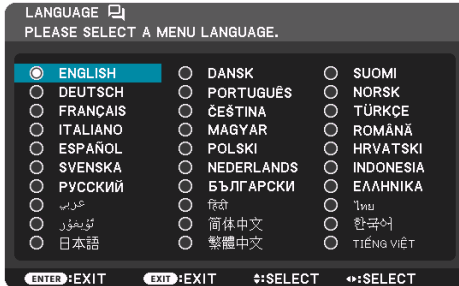

2. Press the ENTER button to execute the selection.

After this has been done, you can proceed to the menu operation.

If you want, you can select the menu language later.

- After the language is set, the ADMIN PASSWORD setting screen appears.
Make this setting as necessary. (→ page 131)

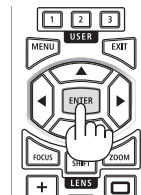

NOTE:

- If the message, [PLEASE SET "DATE AND TIME".] is shown, please set the current date and time.
In the case this message is not shown, the [DATE AND TIME SETTINGS] is recommended to complete.
- Keep the lens cap off the lens while the projector's power is on.
If the lens cap is on, it could be warped due to high temperature.
- If the STATUS indicator lights orange with the power button pressed, the projector will not be turned on since the [CONTROL PANEL LOCK] has been [ON]. Cancel the lock by turning it off.
- While the POWER indicator is blinking blue in short cycles, the power cannot be turned off by using the power button.
- If the projector is kept in sleep mode or other similar state, the temperature of the internal components could rise even when the projector is being used within its normal operating temperate. If the power is turned on in that state, the cooling fan will turn on and the image will be projected after a short while.

2-4. Selecting a Source

Selecting the computer or video source

NOTE:

- Turn on the computer or video source equipment connected to the projector.

Detecting the Signal Automatically

Press the INPUT button for 1 second or longer. The projector will search for the available input source and display it. The input source will change as follows:

HDMI1 → HDMI2 → HDBaseT → HDMI1 → ...

- Press it briefly to display the [INPUT] screen.

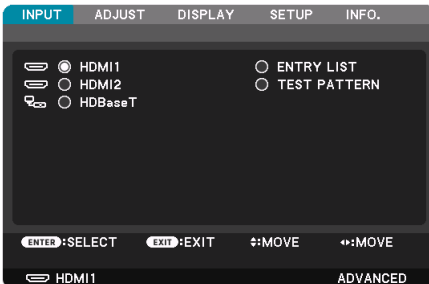
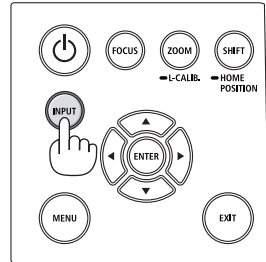

- Press the ▼/▲ buttons to match the target input terminal and then press the ENTER button to switch the input. To delete the menu display in the [INPUT] screen, press the MENU or EXIT button.

TIP:

- If no input signal is present, the input will be skipped.

Using the Remote Control

Press any one of the HDMI1, HDMI2, or HDBaseT button.

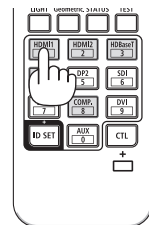

Selecting Default Source

You can set a source as the default source so that it will be displayed each time the projector is turned on.

1. Press the MENU button.

The menu will be displayed.

2. Press the ► button to select [SETUP] and press the ▼ button or the ENTER button to select [MENU(1)].

3. Press the ► button to select [SOURCE OPTIONS] and press the ▼ button or the ENTER button.

4. Select [DEFAULT INPUT SELECT] and press the ENTER button.

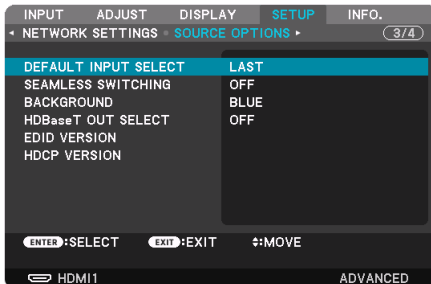

The [DEFAULT INPUT SELECT] screen will be displayed.

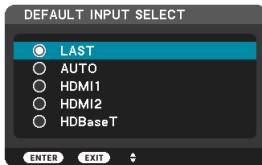

5. Select a source as the default source, and press the ENTER button.

6. Press the EXIT button a few times to close the menu.

7. Restart the projector.

The source you selected in step 5 will be projected.

2-5. Adjusting the Picture Size and Position

Use the lens shift, the adjustable tilt foot, the zoom and the focus to adjust the picture size and position.

Repeat these adjustments until you obtain the optimal projection conditions.

In this chapter drawings and cables are omitted for clarity.

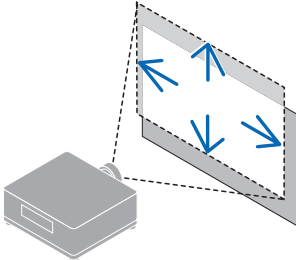
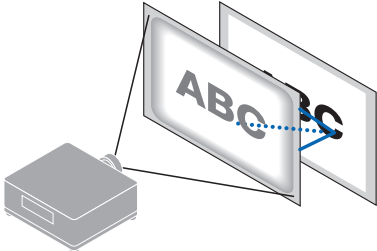
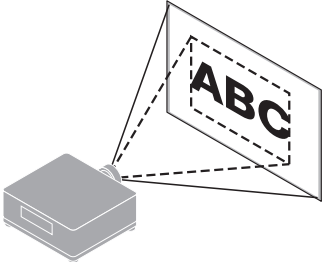
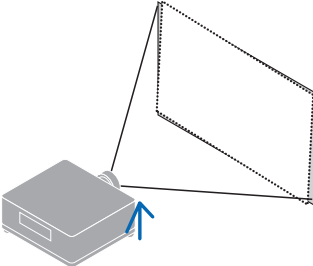
<p>Adjusting the projected image's vertical and horizontal position "Lens shift" (→ page 28)</p>  <p>The diagram shows a projector on the left projecting an image of the letters 'ABC' onto a screen. Four blue arrows point from the center of the image towards the corners of the screen, indicating the direction of lens shift adjustments.</p>	<p>Adjusting the focus "Focus" (→ page 30)</p>  <p>The diagram shows a projector on the left projecting an image of the letters 'ABC' onto a screen. A blue arrow points from the projector towards the screen, indicating the focus adjustment.</p>
<p>Finely adjusting the size of an image "Zoom" (→ page 33)</p>  <p>The diagram shows a projector on the left projecting an image of the letters 'ABC' onto a screen. A dashed box around the letters indicates the zoomed-in area.</p>	<p>Adjusting the projected image's inclination "Tilt foot" (→ page 34)</p>  <p>The diagram shows a projector on the left projecting an image onto a screen. A blue arrow points upwards from the projector's base, indicating the tilt foot adjustment.</p>

Adjusting the vertical position of a projected image (Lens shift)

CAUTION

- Perform the adjustment from behind or from the side of the projector. If adjustments are performed from the front, your eyes could be exposed to strong light and get injured.
- Keep hands away from the lens mounting portion while performing a lens shift. Failure to do so could result in fingers being pinched by the moving lens.

1. Press either **SHIFT/HOME POSITION** button on the cabinet or **SHIFT** button on the remote control.

The [LENS SHIFT] screen will be displayed.

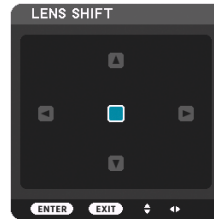

2. Press the **▼▲◀▶** buttons to move the projected image.

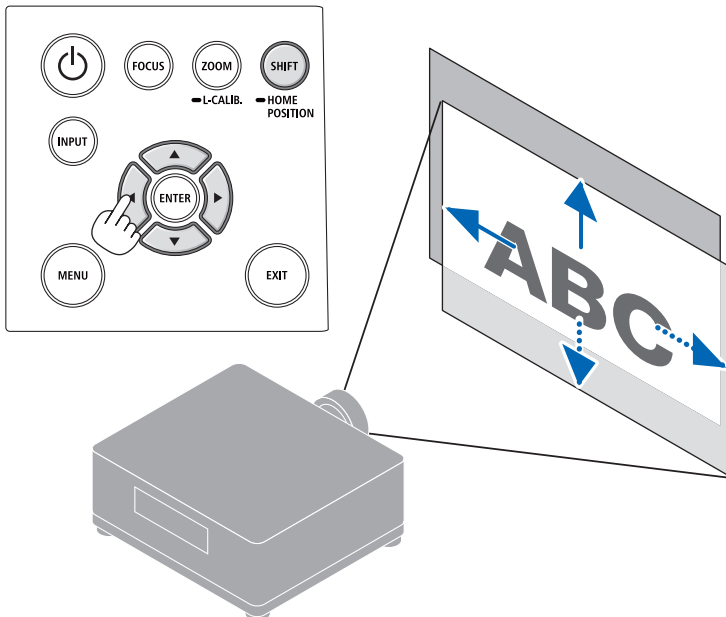

To set back the lens to the home position

Press and hold the **SHIFT/HOME POSITION** button over 2 seconds. The lens mounted on the projector goes back to the home position. (roughly to the center position)

2. Projecting an Image (Basic Operation)

NOTE:

- If the lens is shifted to the maximum in the diagonal direction, the screen peripheral area will be dark or shaded.
- Fix the XP-50ZL/NP50ZL to the projector using the supplied support kit. Loosen the bolts of the support kit, you can adjust the lens shift.
- Fix the XP-44ML/NP44ML to the projector using the separately sold support kit (XP-02LK/NP02LK). Lens shift is not available for the XP-44ML/NP44ML.

TIP:

- The figure below shows the lens shift adjustment range (projection method: Desktop/Front) of the XP-41ZL lens unit. See page 168 for other lens units.

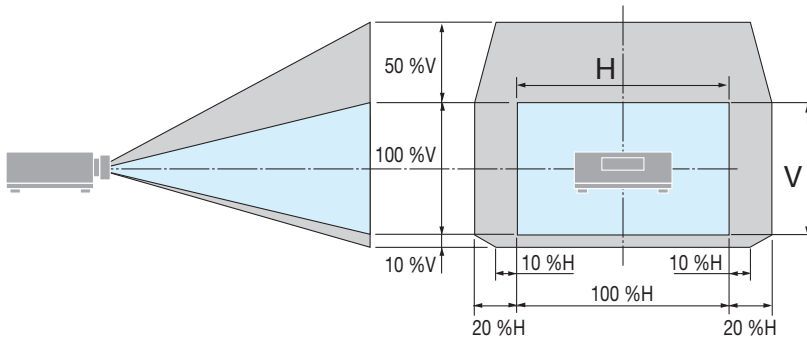

Description of symbols: V indicates vertical (height of the projected image), H indicates horizontal (width of the projected image).

Focus

- Recommend to perform the focus adjustment after leaving the projector under the state the TEST PATTERN has been projected for over 30 minutes.

Applicable lens: XP-40ZL/XP-41ZL/NP40ZL/NP41ZL

1. Press the FOCUS button.

The [LENS FOCUS] control screen will be displayed on.

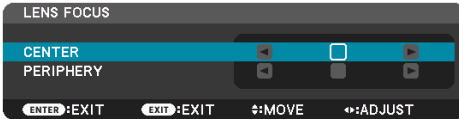

Press ◀▶ buttons to adjust focus.

2. When the cursor is on the [CENTER] on on-screen menu, press either ◀ or ▶ button to align focus around the optical axis.

- * The picture shows an example when the lens shift is moved upward. Adjust the lens until the bottom edge of the projection screen is in focus.

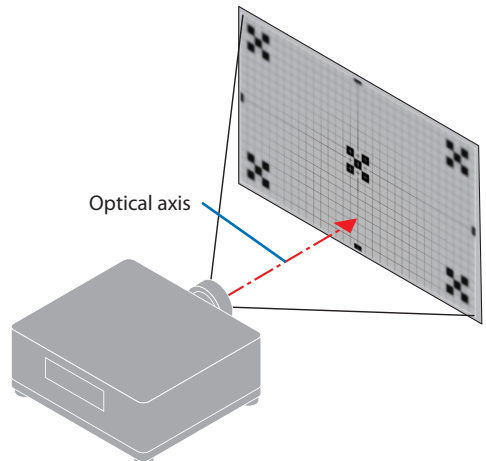
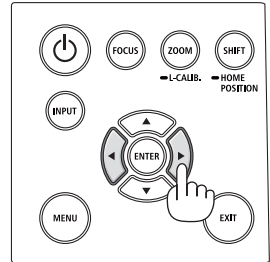
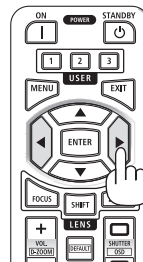
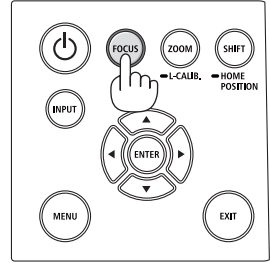
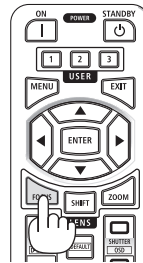

2. Projecting an Image (Basic Operation)

3. Press **▼** button to select the [PERIPHERY] on the on-screen menu, and then press either **◀** or **▶** button to align the focus of screen peripheral area.



4. Repeat steps 2 and 3 until the entire projection screen is in focus.

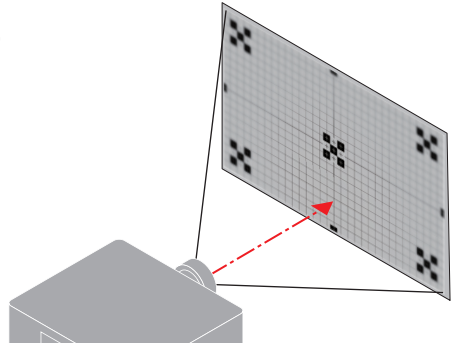

Applicable lens: XP-43ZL/XP-50ZL/NP43ZL/NP50ZL

1. Press the FOCUS button.

The [LENS FOCUS] control screen will be displayed on.



Press **◀▶** buttons to adjust focus.

* [PERIPHERY] LENS FOCUS is not available for this lens unit.

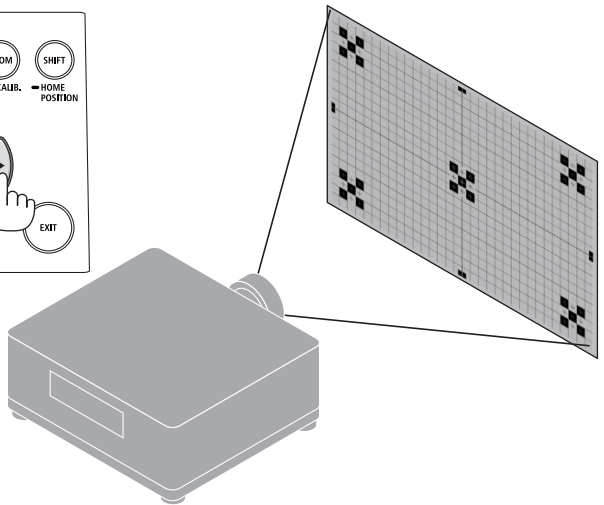
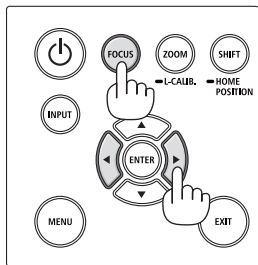
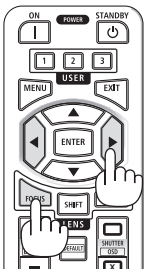

Applicable lens: XP-44ML/NP44ML

- The XP-44ML/NP44ML must be fixed to the projector using the separately sold support kit (XP-02LK/NP02LK).

The support kit is not shown on this illustration.

1. Press the FOCUS button.

The [LENS FOCUS] control screen will be displayed on.



Press ◀▶ buttons to adjust focus of screen center.

- * Does not work for [PERIPHERY] on the [LENS FOCUS] screen. Use the [LENS ZOOM] control screen to adjust the focus of the peripheral area.

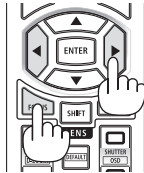

2. Press the ZOOM/L-CALIB. button on the cabinet.

The [LENS ZOOM] control screen will be displayed on.

- * In another way, press the ZOOM button on the remote control.



Press ◀▶ buttons to align the focus of screen peripheral area.

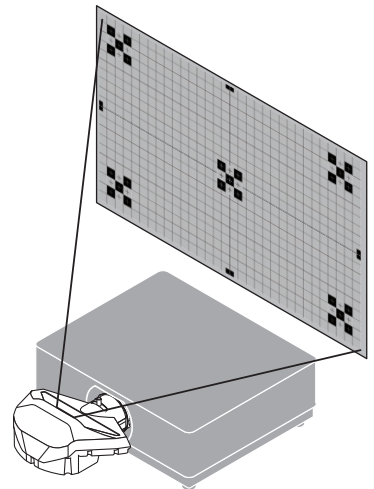
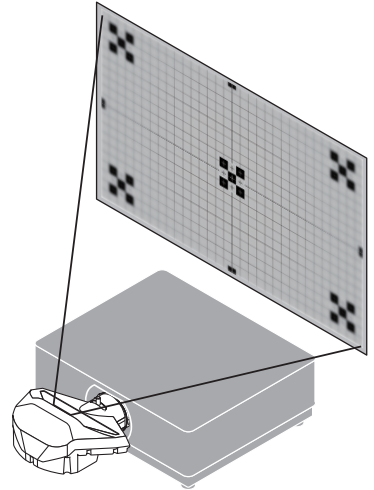
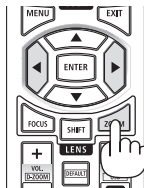

Zoom

Applicable lens: XP-40ZL/XP-41ZL/XP-43ZL/XP-50ZL/
NP40ZL/NP41ZL/NP43ZL/NP50ZL

1. Press ZOOM/L-CALIB. button.

The [ZOOM] adjustment screen will be displayed on.



* In another way, press the ZOOM button on the remote control.

Press ◀▶ buttons to adjust zoom.

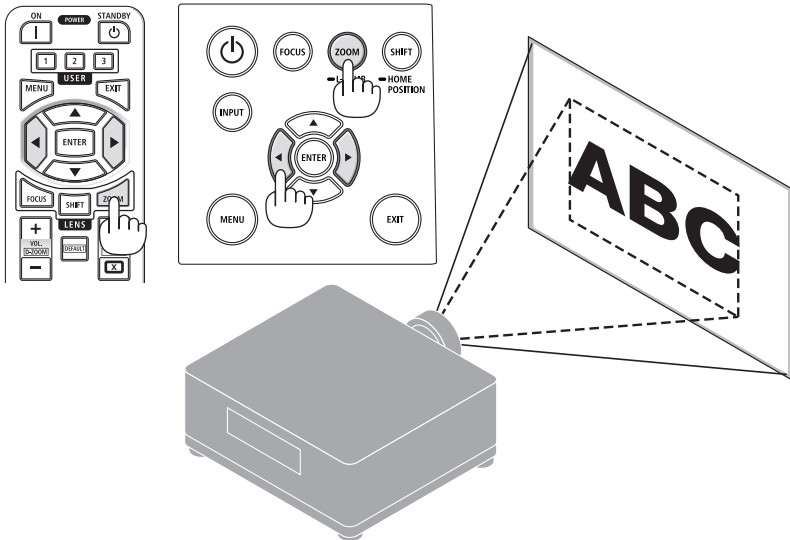

Adjusting the Tilt Foot

1. Turn the left and right tilt foot to adjust.

The tilt foot lengthen and shorten when turned. Turn one of the tilt foot to adjust the image so that it is level.

- The tilt foot can be lengthened by a maximum of 10 mm/0.4".
- The tilt foot can be used to tilt the projector by a maximum of 1.4°.

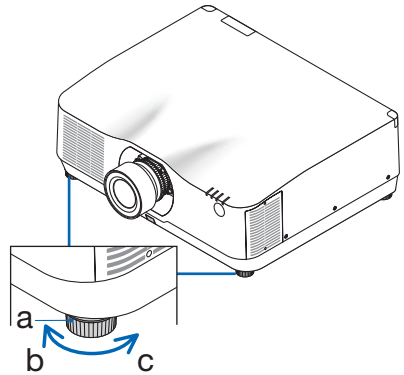
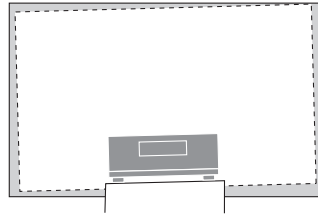

a: Tilt foot / b: Up / c: Down

NOTE:

- Do not lengthen the tilt foot any more than 10 mm/0.4". Doing so will make the projector unstable.
- Do not use the tilt foot for any purpose other than adjusting inclination of the projector installation angle. Handling the tilt foot improperly, such as carrying the projector by grasping the tilt foot or hooking it onto a wall using the tilt foot, could damage the projector.

2-6. Adjusting a picture and sound

Adjusting the picture

Display the on-screen menu and adjust the picture. (→ page 81)

Turning Up or Down Volume

Sound level from the AUDIO OUT terminal can be adjusted.

Important:

- Do not turn up the volume to the maximum level on the external speaker system connected to the AUDIO OUT of the projector. Doing so may produce an unexpected, loud sound at the time of turning on or off the projector, causing damage to your hearing. When adjusting the volume on the external speaker system, set volume level of the speaker system to less than half its rating and adjust the volume on the projector to get appropriate sound level.



When no menus appear, the ◀ and ▶ buttons on the projector cabinet work as a volume control.

- On the remote control, press the VOL./D-ZOOM (+) or (-) button.

NOTE:

- The volume cannot be adjusted using the ◀ or ▶ button in the following cases.
 - When the on-screen menu is displayed
 - When the screen is enlarged by pressing the VOL./D-ZOOM (+) (-) buttons while holding down the CTL button on the remote control

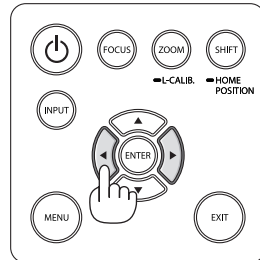
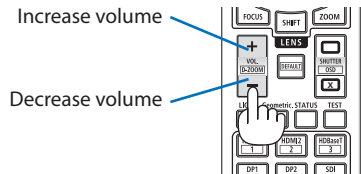



2-7. Turning off the Projector

To turn off the projector:

1. First, press the  (POWER) button on the projector cabinet or the STANDBY button on the remote control.

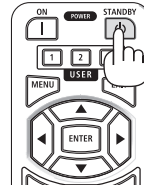
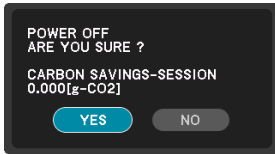
The [POWER OFF / ARE YOU SURE ? / CARBON SAVINGS-SESSION 0.000[g-CO₂]] message will appear.



2. Secondly, press the ENTER button or press the  (POWER) or the STANDBY button again.

The light source will be turned off and the power supply will be cut.

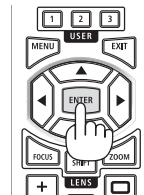

CAUTION

- Parts of the projector may become temporarily heated if the projector is turned off with the POWER button or if the AC power supply is disconnected during normal projector operation. Use caution when picking up the projector.

NOTE:

- While the POWER indicator is blinking blue in short cycles, the power cannot be turned off.
- Do not unplug the power cord from the projector or from the power outlet while an image is being projected. Doing so could deteriorate the projector's AC IN terminal or the power plug's contact. To turn off the AC power while an image is being projected, use the breaker, etc.
- Do not disconnect the AC power supply to the projector within 10 seconds of making adjustment or setting changes and closing the menu. Doing so can cause loss of adjustments and settings.

2-8. After Use

1. **Unplug the power cord from the wall outlet.**
2. **Unplug the power cord from the projector.**
 - ① Pull to an appropriate position while pushing down the knob of the power cord stopper.
 - ② Press down the knob on the clamber to open the clamber and take out the power cord.

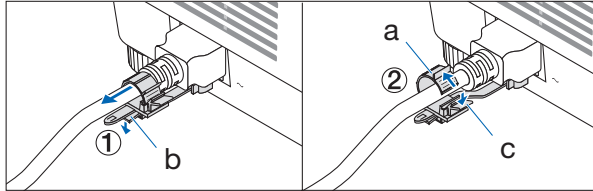

a: Clamber / b: Knob (power cord stopper) / c: Knob (clamber)

3. **Disconnect any other cables.**
4. **Mount the lens cap on the lens.**
5. **Before moving the projector, screw in the tilt foot if they have been lengthened.**

3. Convenient Features

3-1. Turn off the light of the projector (SHUTTER)

1. Press the SHUTTER CLOSE (X) button on the remote control.

The light source will turn off temporarily.

Press the SHUTTER OPEN (□) button to allow the screen to become illuminated again.

- You can set the projection light to gradually fade in or out.

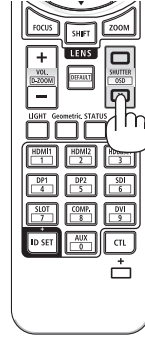

3-2. Turning Off the On-Screen Menu (On-Screen Mute)

1. Hold down the CTL button on the remote control and press the OSD CLOSE (X) button.

The on-screen menu, input terminal, etc. will disappear.

- To display the on-screen display, press the OSD OPEN (□) button while holding down the CTL button on the remote control.

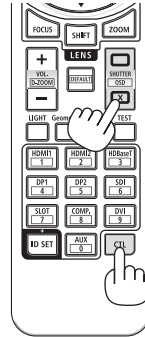

TIP:

- To confirm that the on-screen mute is turned on, press the MENU button. If the on-screen menu is not displayed even though you press the MENU button, it means the on-screen mute is turned on.
 - The on-screen mute is maintained even when the projector is turned off.
 - Holding down the MENU button on the projector cabinet for at least 10 seconds will turn off the on-screen mute.
-

3-3. Enlarging a Picture

You can enlarge the picture up to four times.

NOTE:

- Depending on an input signal, the maximum magnification may be less than four times, or the function may be restricted.

- 1. Press and hold the CTL button and then press VOL./D-ZOOM (+) button on the remote control to magnify the picture.**

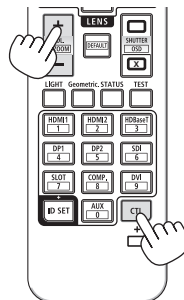
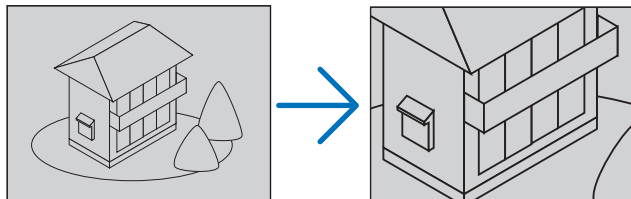

- 2. Press the ▲▼◀▶ button.**

The area of the magnified image will be moved

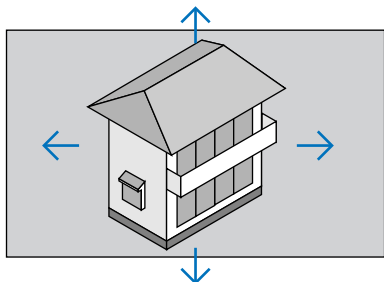

- 3. Press and hold the CTL button and then press VOL./D-ZOOM (-) button on the remote control.**

Each time the button is pressed, the image is reduced.

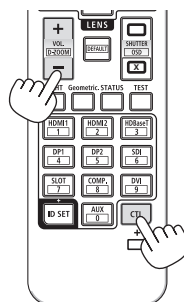

NOTE:

- The image will be enlarged or reduced at the center of the screen.
- Displaying the menu will cancel the current magnification.

3-4. Adjustment of luminance (brightness)

Three [REF. LIGHT MODE] options can be selected according to the purpose of use. Brightness can be adjusted and controlled to maintain a constant brightness after adjustment.

Function name	Description		Page	
REF. LIGHT MODE	The adjustment values of the [REF. LIGHT MODE] and brightness are saved as a setting common to all input signals. Valid when the [MODE] (→ page 91) is set to [STANDARD].		119	
	REF. LIGHT MODE	Icon at the bottom of the menu		Description
	NORMAL	(None)		Standard mode. You can adjust the output from 70 to 100% using [REF. LIGHT ADJUST].
	SILENT	(None)		This mode prioritizes reducing operating noise. You can adjust the output from 70 to 90% using [REF. LIGHT ADJUST].
	LONG LIFE		This mode prioritizes prolonging the life of the optical components. You can adjust the output from 60 to 90% using [REF. LIGHT ADJUST].	
LIGHT MODE	Adjust the brightness and save it for each input signal. Valid when the [MODE] (→ page 91) is set to [PROFESSIONAL].		95	

Display the [LIGHT MODE] screen

1. Press **LIGHT** button on the remote control.

When **[STANDARD]** is selected for **[MODE]**

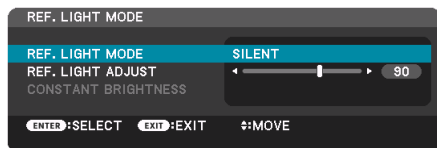

The [REF. LIGHT MODE] screen will be displayed.

When **[PROFESSIONAL]** is selected for **[MODE]**

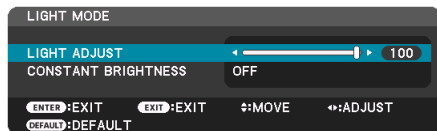

The [LIGHT MODE] screen will be displayed.

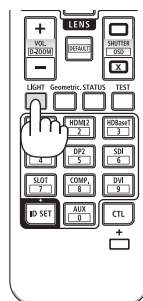

Perform [LIGHT ADJUST]

An explanation is given here using the [REF. LIGHT MODE] screen.

1. Press the **▼** button to adjust the cursor to **[REF. LIGHT ADJUST]**.

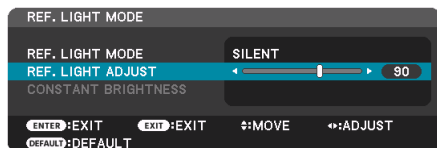

2. Press the **◀▶** button to adjust.

Press the MENU button to cancel the menu screen.

TIP:

- Setting **[CONSTANT BRIGHTNESS]** to **[ON]** will maintain the degree of luminance (brightness) after the light is adjusted.

Change [REF. LIGHT MODE]

1. With the cursor adjusted to [REF. LIGHT MODE], press the ENTER button.

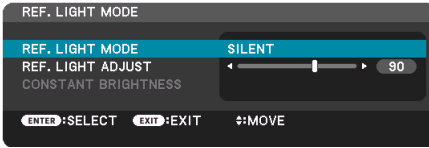

The [REF. LIGHT MODE] selection screen will be displayed.

2. Use the ▼▲ buttons to make a selection, and press the ENTER button.

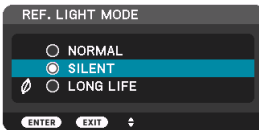

The display will return to the [REF. LIGHT MODE] screen and the selected option will be applied. Press the MENU button to return to the original screen.

NOTE:

- The light module hours used can be checked in [USAGE TIME] on the menu. Select [INFO.] → [USAGE TIME].
 - After a lapse of 1 minute from when the projector displays a blue, black or logo screen, the projector goes into power saving mode and the brightness of the projected image will decrease. When the projector detects the input signal, it will return to original brightness.
 - The projector's protection functions may temporarily reduce luminance (brightness) in hot operating environments. The TEMP. indicator and LIGHT indicator will light up in orange when the protection functions are active. At the same time, the Thermometer symbol [🌡️] is displayed at the lower right of the menu screen. The temperature inside the projector decreases due to the room temperature being lowered, returning to the original brightness.
-

Checking Energy-Saving Effect [CARBON METER]

This will display the energy-saving effect during the period of reduced projector light source as the amount of CO₂ h emission reductions. This feature is called as [CARBON METER].

There are two messages: [TOTAL CARBON SAVINGS] and [CARBON SAVINGS-SESSION]. The [TOTAL CARBON SAVINGS] message shows the total amount of CO₂ emission reduction from the time of shipment up to now. You can check the information on [USAGE TIME] from [INFO.] of the menu. (→ page 143)



The [CARBON SAVINGS-SESSION] message shows the amount of CO₂ emission reduction between the time of changing to [LIGHT MODE] immediately after the time of power-on and the time of power-off. The [CARBON SAVINGS-SESSION] message will be displayed in the [POWER OFF / ARE YOU SURE ?] message at the time of power-off.

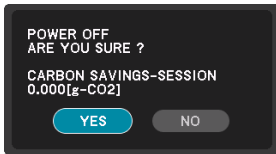

- TIP:
- The formula shown below is used to calculate the amount of CO₂ emission reduction. Amount of CO₂ emission reduction = (Power consumption when using the unit with [REF. LIGHT MODE] set to [NORMAL] and [REF. LIGHT ADJUST] set to 100 - Power consumption in current setting) × CO₂ conversion factor.
 - * Calculation for amount of CO₂ emission reduction is based on an OECD publication "CO₂ Emissions from Fuel Combustion".
 - The [TOTAL CARBON SAVINGS] is calculated based on savings recorded in 15 minutes intervals.
 - The power consumption when the projector is in standby mode is excluded from the calculation of the amount of CO₂ emission reduction.

3-5. Correcting Horizontal and Vertical Keystone Distortion [CORNERSTONE]

Use the [CORNERSTONE] feature to correct keystone (trapezoidal) distortion to make the top or bottom and the left or right side of the screen longer or shorter so that the projected image is rectangular.

1. Project an image so that the screen is smaller than the area of the raster.

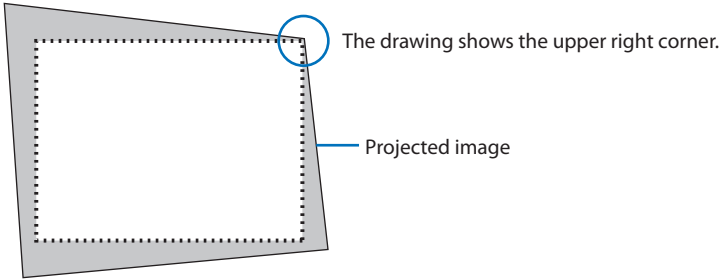

2. Pick up any one of the corners and align the corner of the image with a corner of the screen.

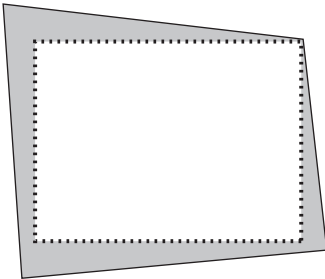

3. Press the Geometric. button either on the cabinet or the remote control.

Display the [GEOMETRIC CORRECTION] screen of the on-screen menu.

4. Move the cursor onto [MODE] by ▼ button and press the ENTER.

The mode selection screen will displayed on.

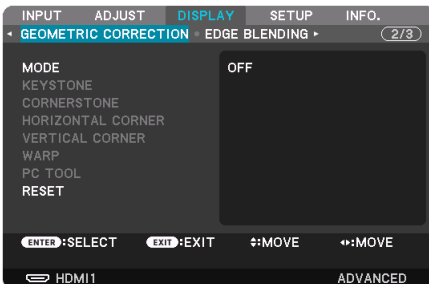

5. Select [CORNERSTONE] and press the ENTER.

Go back to display the [GEOMETRIC CORRECTION] screen of the on-screen menu.

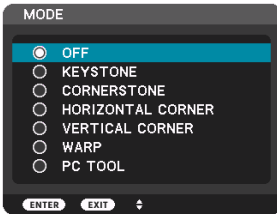

6. Press the ▼ button to align with the [CORNERSTONE] and then press the ENTER button.

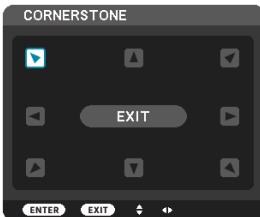

The drawing shows the upper left icon (▼) is selected.

The screen will switch to the [CORNERSTONE] screen.

- 7. Use the ▲▼◀▶ button to select one icon (▲) which points in the direction you wish to move the projected image frame.
- 8. Press the ENTER button.
- 9. Use the ▲▼◀▶ button to move the projected image frame as shown on the example.

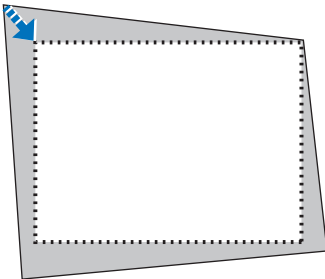

10. Press the ENTER button.

11. Use the ▲▼◀▶ button to select another icon which points in the direction.

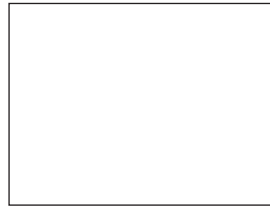
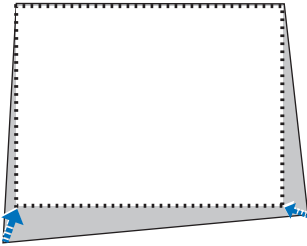

On the [CORNERSTONE] screen, select [EXIT] or press the EXIT button on the remote control.

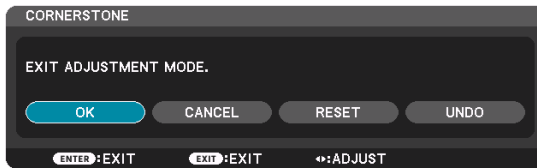

The confirmation screen is displayed.

12. Press the ◀ or ▶ button to highlight the [OK] and press the ENTER button.

This completes the [CORNERSTONE] correction.

- Select [CANCEL] and press the ENTER button to return to the [CORNERSTONE] screen.

Selecting [CANCEL] will return to the adjustment screen without saving changes (Step 3).

Selecting [RESET] will return to the factory default.

Selecting [UNDO] will exit without saving changes.

NOTE:

- Even when the projector is turned on, the last used correction values are applied.
- Carry out either one of the following actions to clear the adjustment value of [CORNERSTONE].
 - In Step 11, select [RESET] and then press the ENTER button.
 - In the state [CORNERSTONE] has been selected for [MODE] in the [GEOMETRIC CORRECTION]:
 - * Press the Geometric. button for 2 or more seconds.
 - * Run [DISPLAY] → [GEOMETRIC CORRECTION] → [RESET] in the on-screen menu.
- Using [CORNERSTONE] correction can cause the image to be slightly blurred because the correction is made electronically.
- A commercially available USB mouse is available for [CORNERSTONE] correction.

3-6. Operation for the On-Screen Menu by a commercially available USB mouse

Once a commercially available USB mouse is connected to this projector, it enables to perform the operation for the on-screen menu and the geometric correction easily.

NOTE:

- Not guarantee the performance of all USB mouse available on the market.

Menu operation

1. Display the on-screen menu by right click.
2. Select a desired menu and perform adjustment by left click.

The adjustment bar can be control by drag and drop.



3. Select [EXIT] displayed at the bottom of the menu by left click for going back to the previous level. If the cursor is on the main menu option, it works for closing the menu. (It works as the same performance with the EXIT button on the remote control.)



Geometric correction

The USB mouse can be used for [CORNERSTONE] CORRECTION, [HORIZONTAL CORNER], [VERTICAL CORNER], and [WARP]. In this clause, the [CORNERSTONE] CORRECTION by an USB mouse is explained as an example.

1. While the adjustment screen of the [CORNERSTONE] CORRECTION is displayed, right click on the projection screen. The shape of mouse pointer will be changed and the correction will become available.
2. Left click at the screen corner. The projection screen corner will move to the mouse clicked position.

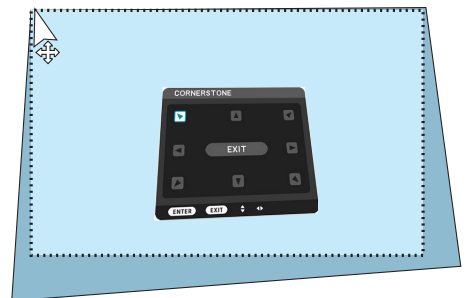
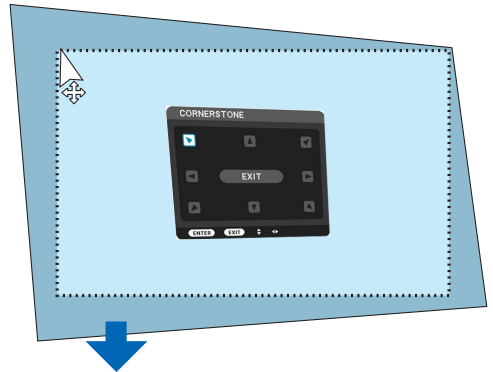
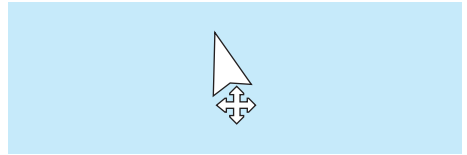

3. Repeat the step 2 for correcting all distortion. After completion of distortion correction, right click on the projection screen. The shape of mouse pointer will be changed to normal.
4. Left click [EXIT] on the correction screen to finish.

3-7. Preventing the Unauthorized Use of the Projector [START-UP LOCK]

A keyword can be set for your projector using the Menu to avoid operation by an unauthorized user. When a keyword is set, turning on the projector will display the START-UP LOCK KEYWORD input screen. Unless the correct keyword is entered, the projector cannot project an image.

NOTE:

- When you enter the keyword, pay enough attention to people around for the keyword abuse prevention.
- If you have anxiety the keyword is cheated, change the keyword immediately.

To enable the START-UP LOCK function:

1. Press the MENU button.

The menu will be displayed.

2. Press the ► button twice to select [SETUP] and press the ▼ button or the ENTER button to select [MENU(1)].

3. Press the ► button to select [CONTROL(2)].

4. Press the ▼ button three times to select [START-UP LOCK] and press the ENTER button.

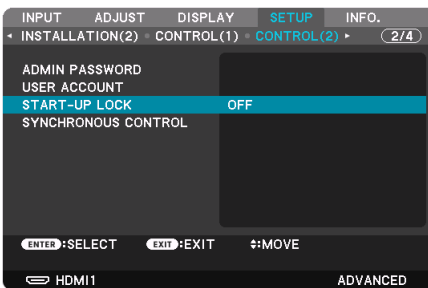

Depending on the ADMIN PASSWORD (→ page 131) settings and status, the password input screen appears.

- If you are logged out, input the ADMIN PASSWORD.
- If it is not yet set, set the ADMIN PASSWORD.

The [START-UP LOCK] screen will be displayed.

5. Press the ▼ button to select [ON] and press the ENTER button.

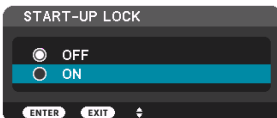

The [START-UP LOCK KEYWORD] screen will be displayed.

6. Type in a combination of the four ▲▼◀▶ buttons and press the ENTER button.

NOTE:

- A keyword must be 4 to 10 digits in length.

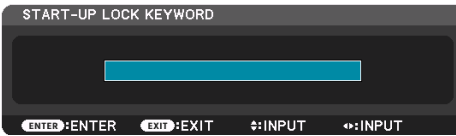

The [CONFIRM KEYWORD] screen will be displayed.

NOTE:

- Make a note of your keyword and store it in a safe place.

7. Type in the same combination of ▲▼◀▶ buttons and press the ENTER button.



The confirmation screen will be displayed.

8. Select [YES] and press the ENTER button.

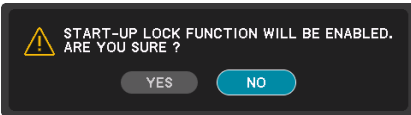

The [START-UP LOCK] function has been enabled.

To turn on the projector when [START-UP LOCK] is enabled:

1. Press the POWER ON button.

The projector will be turned on and display a message to the effect that the projector is locked.

2. Press the MENU button.

The [START-UP LOCK KEYWORD] screen will be displayed.



3. Type in the correct keyword and press the ENTER button. The projector will display an image.

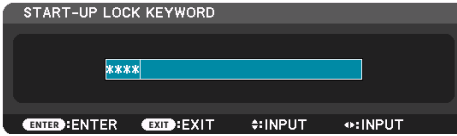

NOTE:

- The START-UP LOCK disable mode is maintained until the main power is turned off or unplugging the power cord.

To disable the [START-UP LOCK] function:

1. Press the MENU button.

The menu will be displayed.

2. Select [SETUP] → [CONTROL(2)] → [START-UP LOCK] and press the ENTER button.

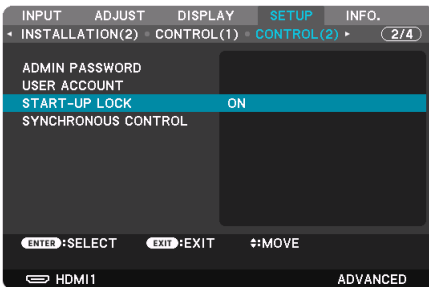

- If the ADMIN PASSWORD (→ page 131) is set and you are logged out, the password input screen appears. Input the ADMIN PASSWORD.

The [START-UP LOCK] screen will be displayed.

3. Select [OFF] and press the ENTER button.

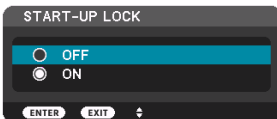

The [START-UP LOCK] function will be disabled.

3-8. Controlling the Projector by Using an HTTP Browser

Overview

You can display the HTTP server screen of the projector by using a web browser and operating the projector with a computer or smartphone.

Possible operations on the HTTP server screen

- Operate the projector.
Operations such power on/off of the projector, input terminal switchover, and lens control etc. can be carried out.
- Adjusting the picture and projection screen, such as picture adjustment, geometric correction, edge blending, etc. is possible.
- Network settings (smartphones are not supported)
Configure the various settings when using the projector connected to a network (wired LAN). Also, it is possible to configure the connection settings with various control systems.
- Changing the [USER ACCOUNT] password
- Registering a background logo (smartphones are not supported)

For details about settings and adjustments, see the explanation on the screen menu.

Important:

- The default [WIRED LAN] setting of this projector is set to [DISABLE] when it is shipped from the factory. To connect to a network, display the on-screen menu and change the [WIRED LAN] profile setting in the [NETWORK SETTINGS] from [DISABLE] to [PROFILE 1] or [PROFILE 2] to enable the [WIRED LAN].
- When setting up a [WIRED LAN] for the first time after purchasing the unit, be sure to set the [ADMIN PASSWORD].

To view the HTTP server screen

For computers

1. **Connect the projector to the computer with a LAN cable sold commercially. (→ page 159)**
2. **Select [SETUP] → [NETWORK SETTINGS] → [WIRED LAN] in the on-screen menu to configure the network settings. (→ page 135)**
3. **Start up the web browser on your computer and enter the address or URL in the input field.**

Specify the address or URL as "http://<IP Address of Projector>/index.html".

The HTTP server screen will be displayed.

For smartphones

1. **Connect a wireless LAN compatible router to the projector with a commercially available LAN cable.**
2. **Select [SETUP] → [NETWORK SETTINGS] → [WIRED LAN] in the on-screen menu to configure the network settings. (→ page 135)**
3. **Configure the network settings of the smartphone so that it can be connected to the projector.**

4. Start up the web browser and enter the address or URL in the input field.

Specify the address or URL as “http://<IP Address of Projector>/index.html”.

The HTTP server screen will be displayed.

NOTE:

- To use the projector in a network, consult with your network administrator about network settings.
 - The display's or button's response can be slowed down or operation may not be accepted depending the settings of your network. Should this happen, consult your network administrator. The projector may not respond if its buttons are repeatedly pressed in rapid intervals. Should this happen, wait a moment and repeat. If you still can't get any response, turn off and back on the projector.
 - If the PROJECTOR NETWORK SETTINGS screen does not appear in the web browser, press the Ctrl+F5 keys to refresh your web browser (or clear the cache).
 - This projector uses “JavaScript” and “Cookies” and the browser should be set to accept these functions. The setting method will vary depending on the version of browser. Please refer to the help files and the other information provided in your software.
-

Preparation before Use

Connect the projector to a commercially available LAN cable before engaging in browser operations. (→ page 159)

Operation with a browser that uses a proxy server may not be possible depending on the type of proxy server and the setting method. Although the type of proxy server will be a factor, it is possible that items that have actually been set will not be displayed depending on the effectiveness of the cache, and the contents set from the browser may not be reflected in operation. It is recommended that a proxy server not be used unless it is unavoidable.

Handling of the Address for Operation via a Browser

Regarding the actual address that is entered for the address or entered to the URL column when operation of the projector is via a browser, the host name can be used as it is when the host name corresponding to the IP address of the projector has been registered to the domain name server by a network administrator, or the host name corresponding to the IP address of the projector has been set in the “HOSTS” file of the computer being used.

Example 1: When the host name of the projector has been set to “pj.sharp.co.jp”, access is gained to the network setting by specifying

http://pj.sharp.co.jp/index.html

for the address or the entry column of the URL.

Example 2: When the IP address of the projector is “192.168.73.1”, access is gained to the network setting by specifying

http://192.168.73.1/index.html

for the address or the entry column of the URL.

HTTP server screen

The screen size of the terminal being used is automatically determined to display the computer screen or smartphone screen.

You can also switch between the computer screen and the smartphone screen manually.

- When switching the display from a computer to a smartphone
Press the [SWITCH TO MOBILE] button at the top right of the screen.
- When switching the display from a smartphone to a computer
Press the menu button at the top left of the screen, and select [SWITCH TO PC PAGE].

Screen for computer

Screen for smartphone



Registering a background logo

An image can be sent to the projector and registered as the background logo. (smartphones are not supported)

A [LOGO] tab is displayed on the HTTP server screen for the computer. Use [SELECT FILE] to choose the image file to be displayed, then enter it using [UPDATE].

Logo image requirements

- File size: Within 256 kilobytes
- Image size: Within the resolution of the projector
- File format: PNG (Full color)

After registering the logo image, when [SETUP] → [SOURCE OPTIONS] → [BACKGROUND] on the on-screen menu is set to [LOGO], the image will be displayed on the background whenever there is no signal.

The logo image will be displayed in the center with the surrounding area in black.

3-9. Storing Changes for Lens Shift, Zoom, and Focus [LENS MEMORY]

This function serves to store the adjusted values when using the [LENS SHIFT], [ZOOM], and [FOCUS] functions of the projector. Adjusted values can be applied to the signal you selected. This will eliminate the need to adjust lens shift, focus, and zoom at the time of source selection. There are two ways to save adjusted values for lens shift, zoom, and focus.

Function name	Description	Page
REF. LENS MEMORY	Adjusted values common to all input signals. At the time of installation, two kinds of adjusted values can be stored. If no adjusted values have been saved to [LENS MEMORY], the lens will apply [REF. LENS MEMORY] adjusted values.	121
LENS MEMORY	Adjusted values for each input signal. Use the adjusted values for the signal with a different aspect ratio or resolution. The adjusted values can be applied at the time of source selection.	102

NOTE:

- Be sure to carry out [LENS CALIBRATION] after replacing the lens.
 - [LENS MEMORY] is not available for the lens units XP-50ZL, XP-44ML, NP50ZL and NP44ML.
-

To store your adjusted values in [REF. LENS MEMORY]:

1. Press the MENU button.

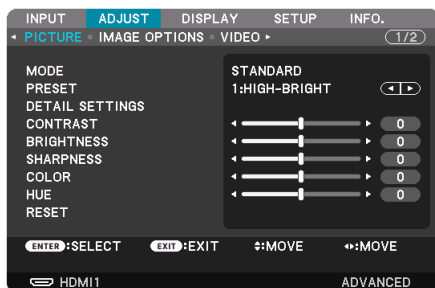

The menu will be displayed.

2. Press the ► button to select [SETUP] and press the ENTER button.

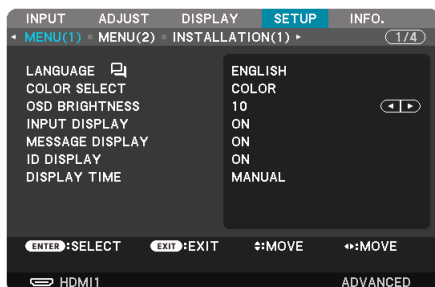

3. Press the ► button to select [INSTALLATION(2)].

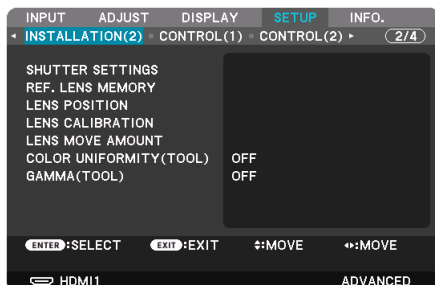

4. Press the ▼ button to select [REF. LENS MEMORY] and press the ENTER button.

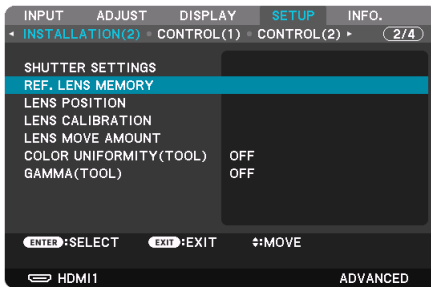

The [REF. LENS MEMORY] screen will be displayed.

5. Make sure [PROFILE] is highlighted, then press the ENTER button.

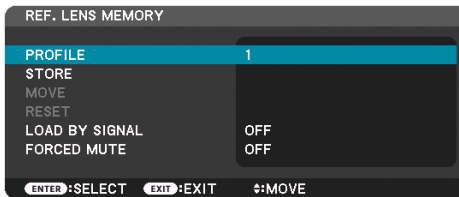

The [PROFILE] selection screen appears.

6. Press the ▼/▲ buttons to select the [PROFILE] number, then press the ENTER button.

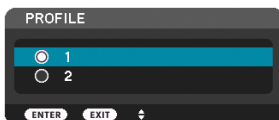

Return to the [REF. LENS MEMORY] settings screen.

7. Select [STORE] and press the ENTER button.

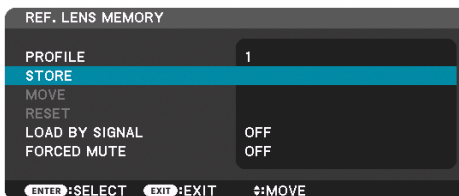

The confirmation screen will be displayed.

8. Press the ◀ button to select and [YES] and press the ENTER button.

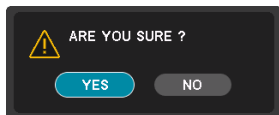

Select a [PROFILE] number and save the adjusted [LENS SHIFT], [ZOOM], and [FOCUS] values to it.

9. Press the MENU button.

The menu will be closed.

TIP:

- To store adjusted values for each input source, use the [LENS MEMORY] function. (→ page [102](#))
-

To call up your adjusted values from [REF. LENS MEMORY]:

1. Press the MENU button.

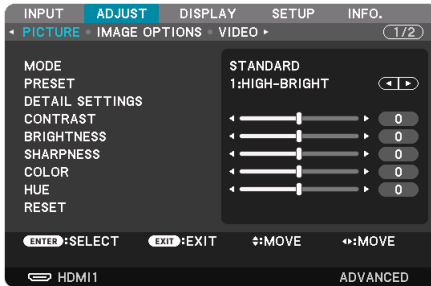

The menu will be displayed.

2. Press the ► button to select [SETUP] and press the ENTER button.



3. Press the ► button to select [INSTALLATION(2)].

4. Press the ▼ button to select [REF. LENS MEMORY] and press the ENTER button.

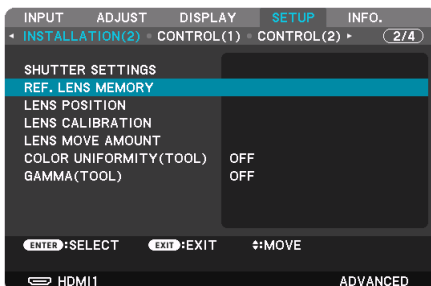

The [REF. LENS MEMORY] screen will be displayed.

5. Make sure [PROFILE] is highlighted, then press the ENTER button.

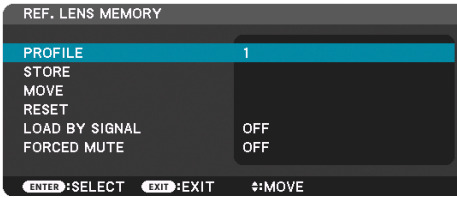

The [PROFILE] selection screen appears.

6. Press the ▼/▲ buttons to select the [PROFILE] number, then press the ENTER button.

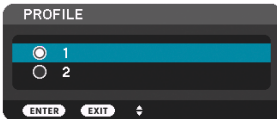

Return to the [REF. LENS MEMORY] settings screen.

7. Select [MOVE] and press the ENTER button.

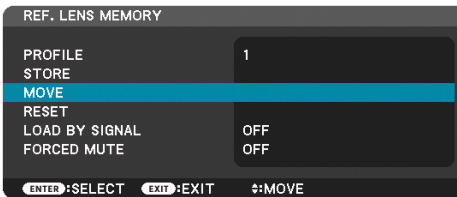

The lens will shift based on the adjusted values stored in the selected [PROFILE].

8. Press the ◀ button to select and [YES] and press the ENTER button.

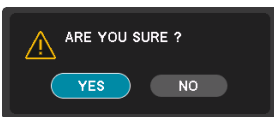

The adjusted values will be applied to the current signal. .

9. Press the MENU button.

The menu will be closed.

TIP:

To call up the stored values from [LENS MEMORY]:

1. From the menu, select [ADJUST] → [LENS MEMORY] → [MOVE] and press the ENTER button.

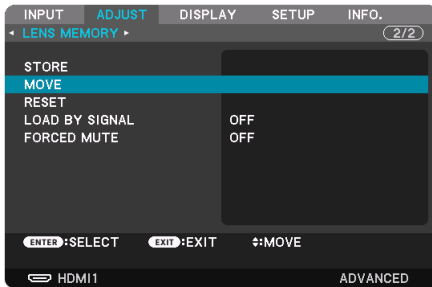

The confirmation screen will be displayed.

2. Press the ◀ button to select and [YES] and press the ENTER button.

During projection, if the adjusted values for an input signal have been saved, the lens will shift. If not, the lens will shift according to the adjusted values stored in the selected [REF. LENS MEMORY] → [PROFILE] number.

To automatically apply the stored values at the time of source selection:

1. From the menu, select [SETUP] → [REF. LENS MEMORY] → [LOAD BY SIGNAL] and press the ENTER button.

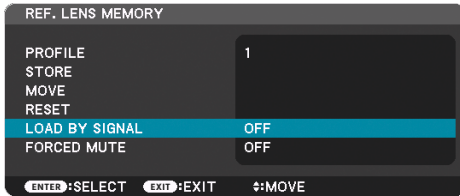

2. Press the ▼ button to select and [ON] and press the ENTER button.

This will move the lens automatically to the position at the time of source selection according to the adjusted values.

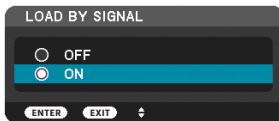

NOTE:

- The [LENS MEMORY] function may not produce a completely aligned image (due to tolerances in the lenses) using the adjusted values stored in the projector. After calling up and applying the stored values from the [LENS MEMORY] function, finely adjust the lens shift, motorized zoom and motorized focus to produce the best possible image.

4. Multi-Screen Projection

This projector can be used singly or arranged in multiple units for multi-screen projection.

4-1. Things that can be done using multi-screen projection

Case 1. Using a single projector to project two types of videos [PIP/PICTURE BY PICTURE]

Connection example and projection image

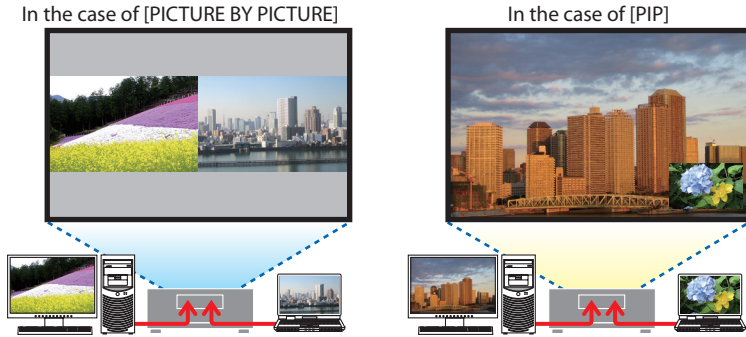

Case 2. Lien up multiple projectors to project a high-resolution image in a larger screen. [TILING]

Connection example and projection image

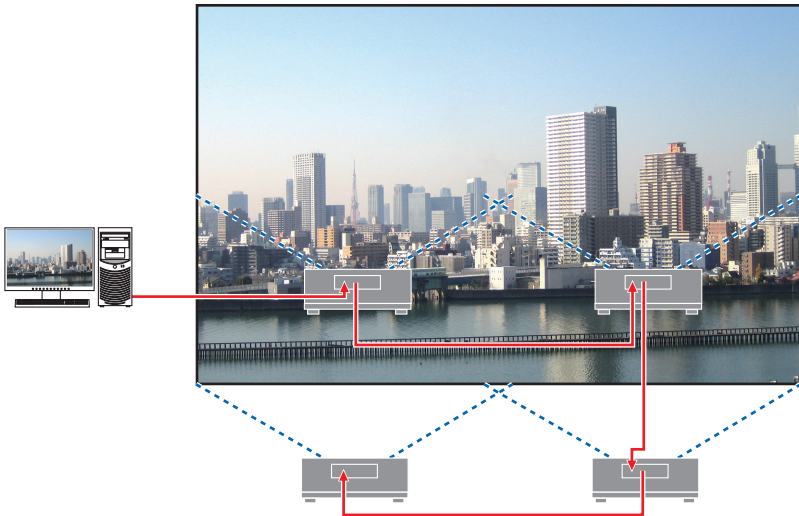

4-2. Using a single projector to project two types of videos at the same time [PIP/PICTURE BY PICTURE]

The projector has a feature that allows you to view two different signals simultaneously. You have two modes: [PIP] mode and [PICTURE BY PICTURE] mode.

The projection video in the first screen display is known as the main display while the projection video that is called out subsequently is known as the sub-display.

Select the projection function under [DISPLAY] → [PIP/PICTURE BY PICTURE] → [MODE] in the on-screen menu (the default factory setting when shipped is [PIP]). (→ page 105)

- A single screen is projected when power is turned on.

Picture in Picture function

A small sub-display is displayed inside the main display.

The sub-display can be set up and adjusted as follows. (→ page 105, 106)

- Select whether to display the sub-display at the top right, top left, bottom right or bottom left of the screen (the size of the sub-display can be selected and the position can be fine-tuned)
- Switch the main display with the sub-display

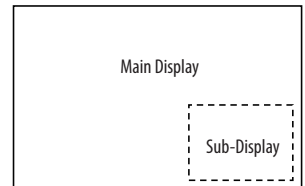

Picture by picture function

Display the main display and sub-display side by side.

The main display and sub-display can be set up and adjusted as follows. (→ page 105, 106)

- Selecting the display boundary (ratio) of the main display and sub-display
- Switch the main display and sub-display

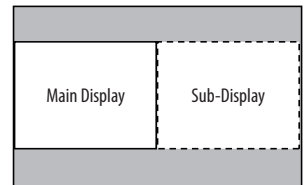

Input terminals that can be used for the main screen and sub-screen.

The main screen and sub-screen can provide the following input terminals.

- The main display and sub-display support computer signals up to WUXGA@60HzRB.

		Sub-Display or additional display		
		HDMI1	HDMI2	HDBaseT
Main Display	HDMI1	No	Yes	Yes
	HDMI2	Yes	No	Yes
	HDBaseT	Yes	Yes	No

NOTE:

- Some signals may not appear depending on the resolution.

Projecting two screens

1. Press the **MENU** button to display the on-screen menu and select **[DISPLAY] → [PIP/PICTURE BY PICTURE]**.

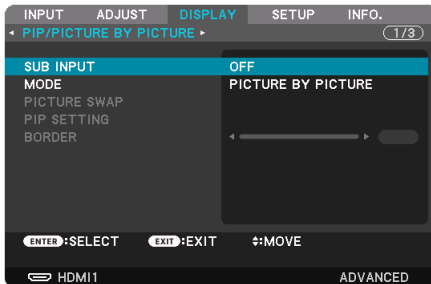

This displays the [PIP/PICTURE BY PICTURE] screen in the on-screen menu.

2. Select **[SUB INPUT]** using the **▼/▲** buttons, and press the **ENTER** button.

This displays the [SUB INPUT] screen.

3. Select the input signal using the **▼/▲** buttons, and press the **ENTER** button.

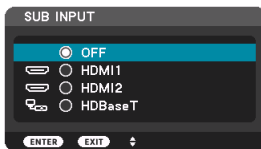

* This screen belongs to a HDBaseT model.

The [PIP] (PICTURE IN PICTURE) or [PICTURE BY PICTURE] screen set up under [MODE] is projected. (→ page 105)

- When the signal name is displayed in grey, this means that it cannot be selected.

4. Press the **MENU** button.

The on-screen menu will disappear.

5. When returning to single screen, display the **[PIP/PICTURE BY PICTURE]** screen one more time and select **[OFF]** in the **[SUB INPUT]** screen of the Step 3.

TIP:

- During dual-screen projection, if the selected input is not supported by the sub-screen, the sub-screen will appear as a black screen.
-

Switching the main display with the sub-display and vice versa

- 1. Press the MENU button to display the on-screen menu and select [DISPLAY] → [PIP/PICTURE BY PICTURE].

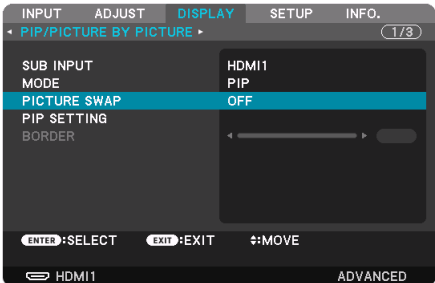

This displays the [PIP/PICTURE BY PICTURE] screen in the on-screen menu.

- 2. Select [PICTURE SWAP] using the ▼/▲ buttons and then press the ENTER button. Display the screen for switching the display positions.
- 3. Select [ON] using the ▼ button and then press the ENTER button.

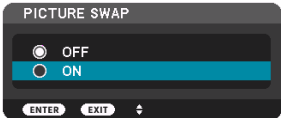

The video of the main display will switch with that of the sub-display.

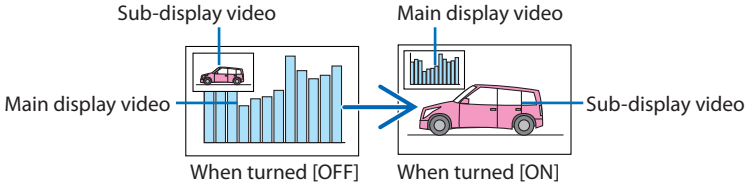

The signal output from the HDBaseT OUT terminal does not change even if the display positions are switched.

- 4. Press the MENU button.

The on-screen menu will disappear.

Restrictions

- The following operations are enabled only for the main display.
 - Audio-visual adjustments
 - Video magnification / compression using the partial VOL./D-ZOOM (+)(-) buttons.
However, magnification / compression is up to the positions set in [PICTURE BY PICTURE] → [BORDER] only.
 - TEST PATTERN
- The HDBaseT OUT port has a repeater function. The output resolution is limited by the maximum resolution of the connected monitor and projector.

4-3. Line up multiple projectors to display a high resolution image in a larger screen [TILING]

This section provides procedures for projecting an image with a resolution of 3840×2160 (4K UHD) by using four projectors.

Preparation:

- Arrange four projectors in a 2×2 layout.
Connect your video output equipment to the four projectors (→ page 160, 161).
- Turn on the power of all devices to project the same four images

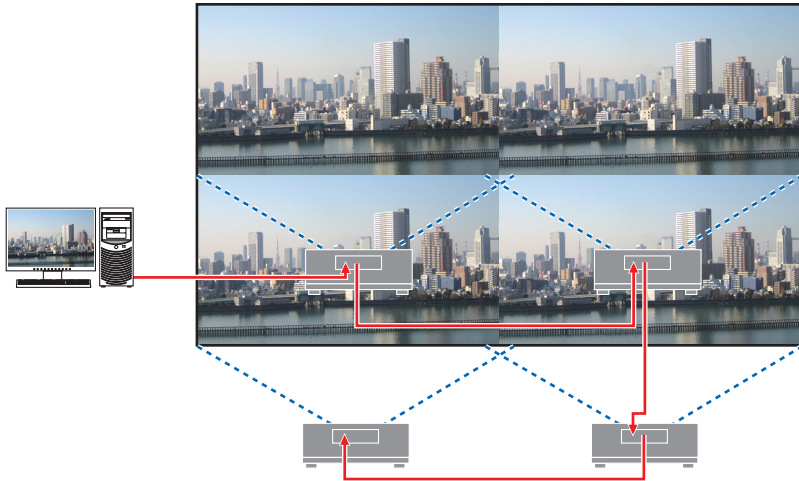

- When performing settings or adjustments using one remote control, enable the [CONTROL ID] for assigning ID to each projector so as not to activate the other projectors. (→ page 128)
- Once all the settings and adjustments are finished, you can also use the [SYNCHRONOUS CONTROL] function to operate 4 projectors with a single remote control. (→ page 76, 133)

NOTE:

- When setting up the projector, assign a unique control ID to each projector.
- Set the "Color setting" and "DeepColor setting" on your Blu-ray player or computer to "Auto". Refer to the owner's manual accompanied with your Blu-ray player or computer for more information.
- Connect an HDMI output of your Blu-ray player or computer to the first projector and then connect to HDBaseT IN port of the second and subsequent projectors.
- Selecting another input source on the second and subsequent projectors will disable the HDBaseT repeater function.

Setting [TILING]

1. Press the MENU button to display the on-screen menu and select [DISPLAY] → [PICTURE SETTING] → [MODE].

This displays the [MODE] screen.

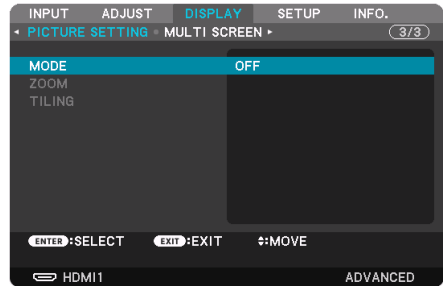

2. Select [TILING] using the ▼/▲ buttons, and press the ENTER button.

The display returns to the [PICTURE SETTING] screen.

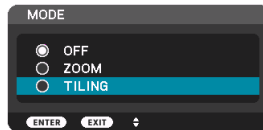

3. Select [TILING] using the ▼/▲ buttons, and press the ENTER button.

This displays the [TILING] screen.

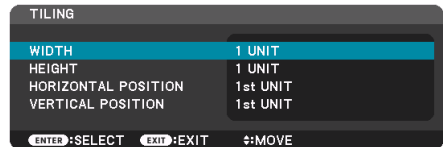

4. Set [WIDTH], [HEIGHT], [HORIZONTAL POSITION], and [VERTICAL POSITION]

- (1) In the screen for setting the number of horizontal units, select [2 UNITS]. (number of units in the horizontal direction)
- (2) In the screen for setting the number of vertical units, select [2 UNITS]. (number of units in the vertical direction)
- (3) In the screen for setting the horizontal order, select [1st UNIT] or [2nd UNIT]. (look at the screens, the one on the left is the [1st UNIT] while the one on the right is the [2nd UNIT])
- (4) In the screen for setting the vertical order, select the [1st UNIT] or the [2nd UNIT]. (look at the screens, the one at the top is the [1st UNIT] while the one at the bottom is the [2nd UNIT])

After completing setting for the steps 1 to 4, a single image will be displayed to fill the screen.



5. Press the MENU button.

The on-screen menu will disappear.

To make boundaries less noticeable of a projected image, use [EDGE BLENDING] to adjust them. (→ [next page](#))

4-4. Adjust boundaries of a projected image [EDGE BLENDING]

This projector is equipped with an "[EDGE BLENDING] Function" that makes the edges (boundaries) of the projection screen indistinguishable.

NOTE:

- Before performing the Edge Blending function, place the projector in the correct position so that the image becomes square in the appropriate size, and then make optical adjustments (lens shift, focus, and zoom).
- Adjust the brightness of each projector using [REF. LIGHT ADJUST] under [REF. LIGHT MODE]. In addition, use [REF. WHITE BALANCE] to adjust the [CONTRAST], [BRIGHTNESS] and [UNIFORMITY].

The following procedure shows an example of four projectors in a 2×2 layout.

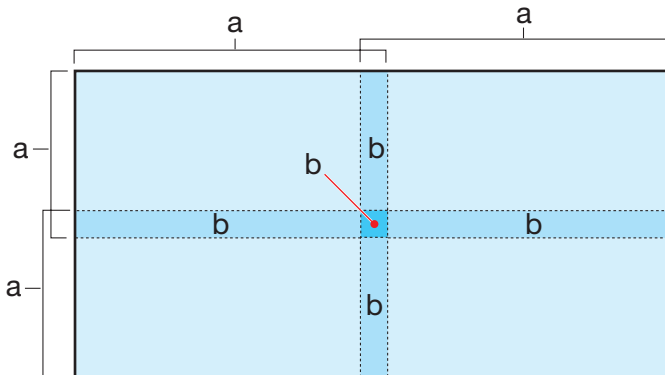

a: Projected area / b: Edge Blending area

Setting the overlap of projection screens

① Enable [EDGE BLENDING].

1. Press the MENU button.

The menu will be displayed.

2. Select [DISPLAY] → [EDGE BLENDING].

The [EDGE BLENDING] screen will be displayed. Align the cursor with [MODE] and then press the ENTER button. The mode screen will be displayed.

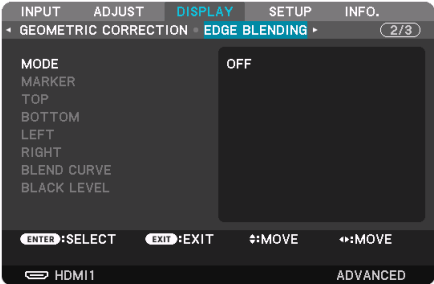

3. Select [MODE] → [ON] and press the ENTER button.

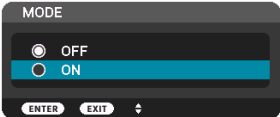

This enables the Edge Blending function. The following menu items are available: [MARKER], [TOP], [BOTTOM], [LEFT], [RIGHT], [BLEND CURVE], and [BLACK LEVEL]

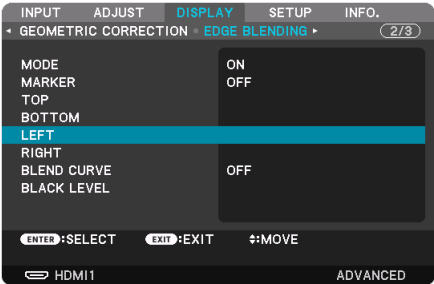

4. Select an appropriate item from [TOP], [BOTTOM], [LEFT], and [RIGHT] for an area of overlapped edges, and turn on [CONTROL].

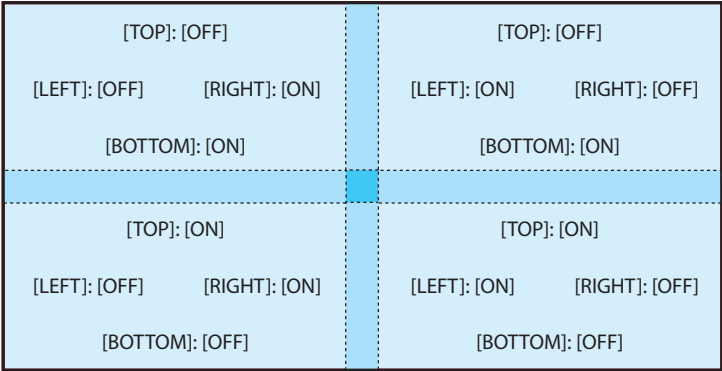
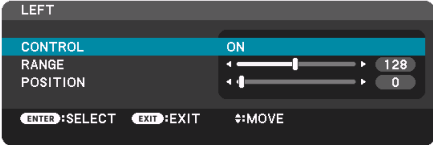

② Adjust [POSITION] and [RANGE] to determine an area of overlapped edges of images projected from each projector.

When [MARKER] is set to [ON], markers of four colors are displayed on the screen. The cyan and green markers represent the edges of the region where images overlap, the magenta and red markers represent the range of overlapping (region/width).

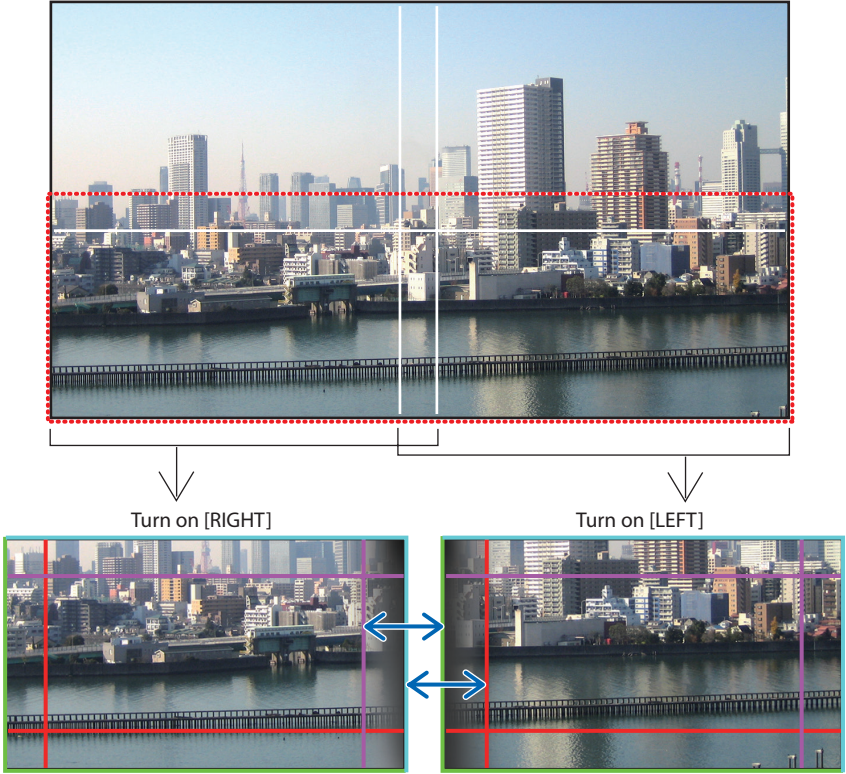

* The 2 screens are separated in the diagram for explanatory purposes.

Fit the edge of the overlapping area to the edge of the image with [POSITION], then adjust the overlapping area (width) with [RANGE]. In the case of the figure on the previous page, first set the cyan marker to the edge of the image on the left screen and the green marker to the edge of the image on the right screen. Next, adjust the magenta marker on the left screen onto the green marker on the right screen, and the red marker on the right screen onto the cyan marker on the left screen. Adjustment is completed when the markers are stacked and become white. Turn off [MARKER] to turn off the marker.

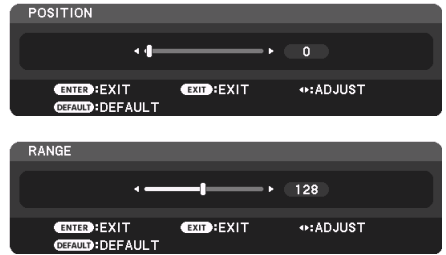

TIP:

- Setting of [MARKER] will not be saved and return to [OFF] when the projector is turned off.
- To display or hide the marker while the projector is running, turn on or off [MARKER] from the menu.

[BLEND CURVE]

Adjust the brightness of the overlapped section on the screens. According to the necessity, adjust the brightness of the overlapped section on the screens by the [BLEND CURVE] and [BLACK LEVEL].

- Set the [MODE] to [ON] for selecting [BLEND CURVE] and [BLACK LEVEL].

Selecting an option for the [BLEND CURVE]

By controlling the graduation of the overlapped section on the screens, it makes the border on the projected screens inconspicuous. Select the optimal option among nine.

1. On the On-Screen Menu, move the cursor onto the [DISPLAY] → [EDGE BLENDING] → [BLEND CURVE] and then press the ENTER. The option setting screen for the [BLEND CURVE] is displayed on.

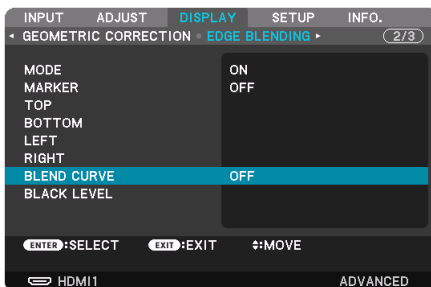

2. Select one option among nine by ▲ or ▼.

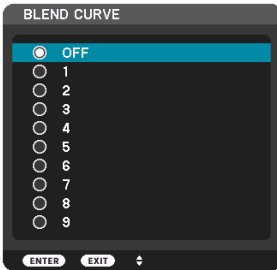

Black Level Adjustment

This adjusts the black level of the overlapping area and the non-overlapping area of the multi-screen (EDGE BLENDING).

Adjust the brightness level if you feel the difference is too large.

NOTE:

- Adjustable area varies depending on what combination of [TOP], [BOTTOM], [LEFT] and [RIGHT] are turned on.

The black level of the lower left projector is adjusted as shown in the figure.

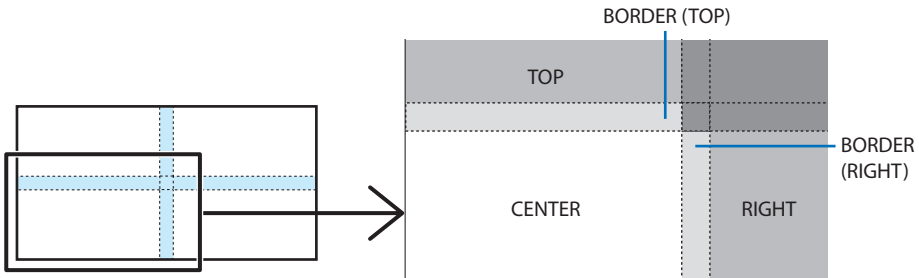

1. Select [DISPLAY] → [EDGE BLENDING] → [BLACK LEVEL] and press the ENTER button.

The screen will switch to the black level adjustment screen.

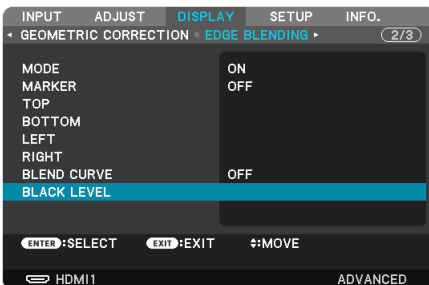

2. Use the ◀, ▶, ▼ or ▲ button to select an item and use the ◀ or ▶ to adjust the black level.

Do this for the other projector if necessary.



Once adjustments of all the projectors are completed, make the [SYNCHRONOUS CONTROL] settings to all four projectors, for example, turn the power of on and off simultaneously with a single remote control. (→ [next page](#))

TIP:

- The number of black level division screens changes depending on the number of edge blending positions selected (top, bottom, right, left). In addition, when the top / bottom and left / right ends are selected, the corner division screen appears.
 - The edge blending width is the width set in the range and the corner is formed by the intersecting area of the top / bottom ends or left / right ends.
 - The [BLACK LEVEL] can be adjusted to make it brighter only.
-

Making the [SYNCHRONOUS CONTROL] setting

This setting is used to operate all the projectors with a single remote control. (→ page 133)

Synchronized functions: POWER ON/OFF, AV MUTE, SHUTTER OPEN/CLOSE, SIGNAL MUTE, DYNAMIC CONTRAST, AUTO BLACK SHUTTER

When the HDBaseT IN port and HDBaseT OUT port are connected in a daisy chain (→ page 160), set the master projector to which the video signal is being input as the main projector.

1. **On the projector that is set to the main projector, select [SETUP] → [CONTROL2] → [SYNCHRONOUS CONTROL], then press the ENTER button.**

The screen switches to the [SYNCHRONOUS CONTROL] setting screen.

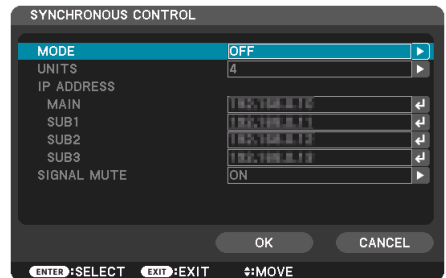

2. **Set [MODE] and [UNITS].**

Set [MODE] to [MAIN] and [UNITS] to [4].

3. **Set the sub-projectors' IP addresses.**

Input the [SUB1], [SUB2] and [SUB3] IP addresses.

4. **Use the ▲ and ▼ buttons to set the cursor to [OK], then press the ENTER button.**

Complete setup for the main projector. The sub-projectors are then notified of the [MODE], [IP ADDRESS] - [MAIN], and [SIGNAL MUTE] settings and synchronous control of four projectors is enabled.

NOTE:

- Synchronous control enables multiple projectors connected via LAN cables to send signals to each other. (→ page 160, 161)
If some of the projectors do not operate when synchronous control is set, check the MAIN and SUB1 to 3 settings at [INFO.] → [SYNCHRONOUS CONTROL] on the on-screen menu.
If [DISCONNECT] is displayed, communications are disabled. Check that all LAN cables are connected and reconfigure synchronous control on the main projector.
[Reconfiguration process]
(1) Set [MODE] to [OFF], move the cursor to [OK], then press the ENTER button.
(2) Set [MODE] to [MAIN], move the cursor to [OK], then press the ENTER button.
If communications are unstable, the operation of the projectors could be slowed down.
- When operating projectors set for synchronous control using the remote control, use the CONTROL ID or REMOTE terminal (→ page 17) to operate only the main projector.

Adjust using a computer or smartphone

[EDGE BLENDING] can be easily done using a computer or smartphone connected to the projectors via a network.

Connect to the HTTP server (→ page 52) and display the [EDGE BLENDING] tab.

Screen for computer

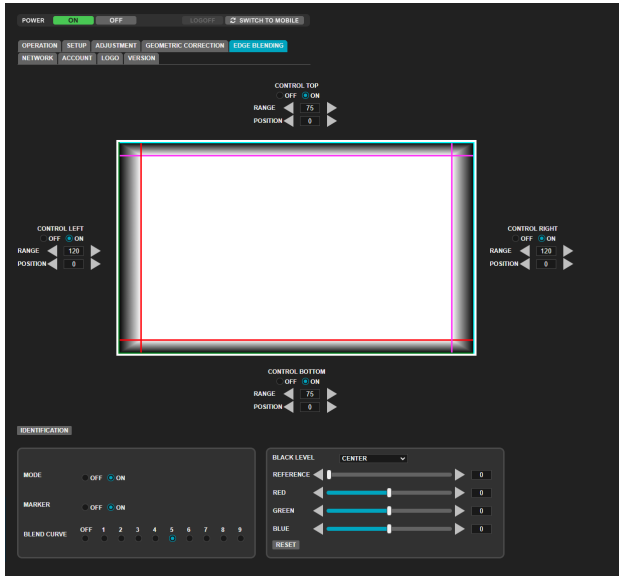

Screen for smartphone

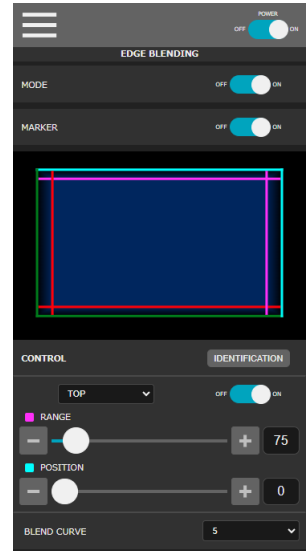

The [EDGE BLENDING] setting/adjustment items are displayed on one screen and can be operated using the mouse of the computer or the touch screen of the smartphone. For details of each setting/adjustment, refer to the On-Screen Menu explanation.

- [POSITION] and [RANGE] can be adjusted by moving the markers (cyan, green, magenta, red line) by clicking and dragging with the mouse (or swiping the smartphone).
- The following adjustment values can be finely adjusted with the ←/→ button on the keyboard:
 - POSITION
 - RANGE
 - [REFERENCE] for [BLACK LEVEL], [RED], [GREEN], [BLUE]
- To check which screen of the projector you are adjusting, press the [IDENTIFICATION] button. The identification message (IP address) will be displayed on the screen for 3 seconds.

5. Using On-Screen Menu

5-1. Using the Menus

NOTE:

- The on-screen menu may not be displayed correctly while interlaced motion video image is projected.

1. Press the MENU button on the remote control or the projector cabinet to display the menu.

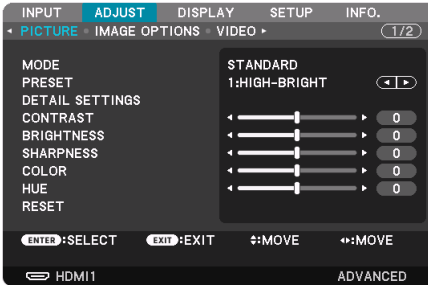

NOTE:

- The commands such as ENTER, EXIT, ▲▼, ◀▶ in the bottom show available buttons for your operation.

2. Press the ◀▶ buttons on the remote control or the projector cabinet to display the sub-menu.

3. Press the ENTER button on the remote control or the projector cabinet to highlight the top item or the first tab.

4. Use the ▲▼ buttons on the remote control or the projector cabinet to select the item you want to adjust or set.

You can use the ◀▶ buttons on the remote control or the projector cabinet to select the tab you want.

5. Press the ENTER button on the remote control or the projector cabinet to display the submenu window.

6. Adjust the level or turn the selected item on or off by using the ▲▼◀▶ buttons on the remote control or the projector cabinet.

Changes are stored until adjusted again.

7. Repeat steps 2-6 to adjust an additional item, or press the EXIT button on the remote control or the projector cabinet to quit the menu display.

NOTE:

- When a menu or message is displayed, several lines of information may be lost, depending on the signal or settings.

8. Press the MENU button to close the menu.

To return to the previous menu, press the EXIT button.

5-2. Menu Elements

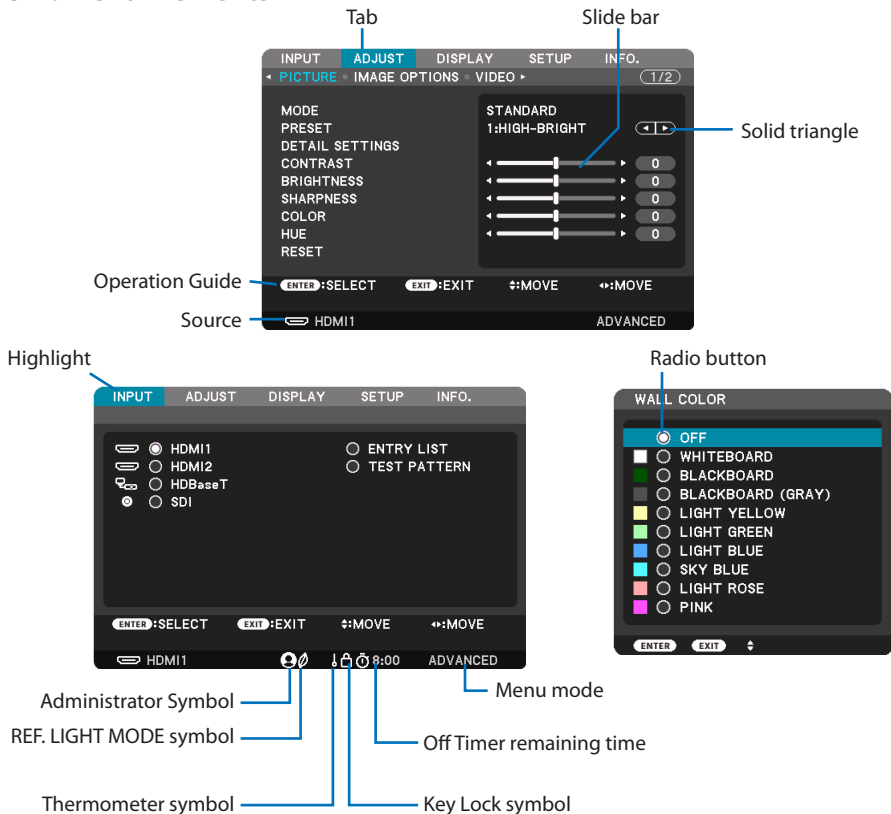

Menu windows or dialog boxes typically have the following elements:

Highlight	Indicates the selected menu or item.
Solid triangle	Indicates further choices are available. A highlighted triangle indicates the item is active.
Tab	Indicates a group of features in a dialog box. Selecting on any tab brings its page to the front.
Operation Guide	Indicates the buttons that can be used. Simultaneously pressing the CTL and DEFAULT buttons on the remote while selecting items here that have [DEFAULT] displayed next to them will reset the adjustment values to their default values.
Radio button	Use this round button to select an option in a dialog box.
Source	Indicates the currently selected source.
Menu mode	Indicates the current menu mode: [BASIC] or [ADVANCED].
Off Timer remaining time	Indicates the remaining countdown time when the [OFF TIMER] is preset.
Slide bar	Indicates settings or the direction of adjustment.
Administrator Symbol	This indicates that you are logged in with the [ADMIN PASSWORD].
REF. LIGHT MODE symbol	Indicates [REF. LIGHT MODE] is set to [LONG LIFE].
Key Lock symbol	Indicates the [CONTROL PANEL LOCK] is enabled.
Thermometer symbol	Indicates that the heat protection functions are operating.

Using the character input screen

Highlight the item for text input and press the ENTER button to bring up the character input screen.

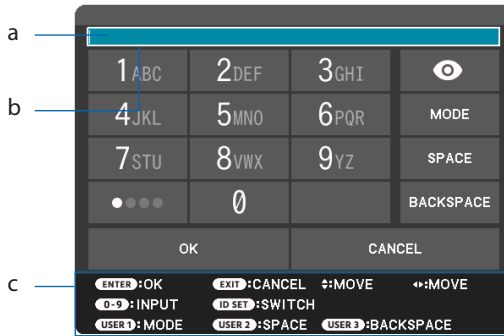

a: Text box / b: Highlight / c: Operation Guide

1. Press the ▼▲◀▶ buttons to highlight a character and then press the ENTER button.

The character will be entered.

Do the following for non-character items.

Item	Function	Corresponding button on the remote control
	Toggles between displaying characters or an asterisk in the text box.	—
MODE	Toggles between upper case, lower case, and special characters.	
SPACE	Inserts a space.	
BACKSPACE	Deletes the character to the immediate left of the cursor.	
	Switches the character to be entered. Example: 1 → A → B → C	
OK	Confirms the characters that have been entered and closes the character input screen.	
CANCEL	Deletes the characters that have been entered and closes the character input screen.	

Characters can also be input without moving the highlighting by pressing the buttons on the remote control (0-9).

Check the operations guide display to see which buttons on the remote control correspond with which items on the character input screen.

2. After inputting characters, use the ▼▲◀▶ buttons to focus on either OK or the text box, then press the ENTER button.

The characters that have been entered will be confirmed, and the character input screen will close.

5-3. List of Menu Items

- Some menu items are not available depending on the input source.
- [BASIC] menu items are indicated by shaded area.

Menu Item		Default	Options
INPUT	HDMI1		
	HDMI2		
	HDBaseT		
	ENTRY LIST		
	TEST PATTERN		
ADJUST	PICTURE	MODE	STANDARD, PROFESSIONAL
		PRESET	* AUTO, 1:HIGH-BRIGHT, 2:PRESENTATION, 3:VIDEO, 4:CINEMA, 5:GRAPHIC, 6:sRGB, 7:DICOM SIM.
		DETAIL SETTINGS	
		GENERAL	
		REFERENCE	* HIGH-BRIGHT, PRESENTATION, VIDEO, CINEMA, GRAPHIC, sRGB, DICOM SIM.
		GAMMA SETTING	
		SCREEN SIZE* ¹	* LARGE, MEDIUM, SMALL
		COLOR TEMPERATURE* ²	*
		DYNAMIC CONTRAST	NORMAL OFF, NORMAL, ENHANCED
		AUTO BLACK SHUTTER	OFF OFF, ON
		LIGHT MODE	*
		LIGHT ADJUST	
		CONSTANT BRIGHTNESS	OFF OFF, ON
		WHITE BALANCE	
		CONTRAST R	0
		CONTRAST G	0
		CONTRAST B	0
		BRIGHTNESS R	0
		BRIGHTNESS G	0
		BRIGHTNESS B	0
		COLOR CORRECTION	
		RED	* HUE, SATURATION, BRIGHTNESS
		GREEN	* HUE, SATURATION, BRIGHTNESS
		BLUE	* HUE, SATURATION, BRIGHTNESS
		YELLOW	* HUE, SATURATION, BRIGHTNESS
		MAGENTA	* HUE, SATURATION, BRIGHTNESS
		CYAN	* HUE, SATURATION, BRIGHTNESS
		CONTRAST	0
		BRIGHTNESS	0
		SHARPNESS	*
		COLOR	0
		HUE	0
(VOLUME)* ³	10		
RESET			

* The asterisk (*) indicates that the default setting varies depending on the signal.

*¹ The [SCREEN SIZE] item is available when [DICOM SIM.] is selected for [REFERENCE].

*² When [HIGH-BRIGHT] is selected in [REFERENCE], the [COLOR TEMPERATURE] is not available.

*³ [VOLUME] is not displayed in the [ADVANCED] menu.

5. Using On-Screen Menu

		Menu Item	Default	Options	
ADJUST	IMAGE OPTIONS	HORIZONTAL	*		
		VERTICAL	*		
		BLANKING	*	TOP, BOTTOM, LEFT, RIGHT	
		OVERSCAN		AUTO, 0[%], 5[%], 10[%]	
		ASPECT RATIO	AUTO	(HDTV/SDTV) AUTO, NORMAL, 4:3, LETTERBOX, WIDE SCREEN, ZOOM, FULL	
	VIDEO	NOISE REDUCTION	OFF	OFF, LOW, MEDIUM, HIGH	
		DEINTERLACE	NORMAL	NORMAL, MOVIE, STILL	
		SIGNAL TYPE	AUTO	AUTO, RGB, REC601, REC709, REC2020	
		VIDEO LEVEL	AUTO	AUTO, NORMAL, ENHANCED, SUPER WHITE	
	LENS MEMORY	HDR MODE*4	AUTO	AUTO, OFF, ON	
		STORE			
		MOVE			
		RESET			
		LOAD BY SIGNAL	OFF	OFF, ON	
		FORCED MUTE	OFF	OFF, ON	
DISPLAY	PIP/PICTURE BY PICTURE	SUB INPUT	OFF	OFF, HDMI1, HDMI2, HDBaseT	
		MODE	PIP	PIP, PICTURE BY PICTURE	
		PICTURE SWAP	OFF	OFF, ON	
		PIP SETTING	START POSITION	TOP-LEFT	TOP-LEFT, TOP-RIGHT, BOTTOM-LEFT, BOTTOM-RIGHT
			HORIZONTAL POSITION		
	VERTICAL POSITION				
	SIZE		MEDIUM	LARGE, MEDIUM, SMALL	
	BORDER				
	GEOMETRIC CORRECTION	MODE	OFF	OFF, KEYSTONE, CORNERSTONE, HORIZONTAL CORNER, VERTICAL CORNER, WARP, PC TOOL	
		KEYSTONE	HORIZONTAL		
			VERTICAL		
			HORIZONTAL SHIFT		
			VERTICAL SHIFT		
			THROW RATIO		
		CORNERSTONE		TOP-LEFT, TOP, TOP-RIGHT, LEFT, RIGHT, BOTTOM-LEFT, BOTTOM, BOTTOM-RIGHT	
		HORIZONTAL CORNER		TOP-LEFT, TOP, TOP-RIGHT, LEFT, RIGHT, BOTTOM-LEFT, BOTTOM, BOTTOM-RIGHT	
		VERTICAL CORNER		TOP-LEFT, TOP, TOP-RIGHT, LEFT, RIGHT, BOTTOM-LEFT, BOTTOM, BOTTOM-RIGHT	
WARP			TOP-LEFT, TOP, TOP-RIGHT, LEFT, RIGHT, BOTTOM-LEFT, BOTTOM, BOTTOM-RIGHT		
PC TOOL		OFF	OFF, 1, 2, 3		
RESET					

*4 The [HDR MODE] item is available exclusively for 4K signal.

5. Using On-Screen Menu

		Menu Item	Default	Options	
DISPLAY	EDGE BLENDING	MODE	OFF	OFF, ON	
		MARKER	OFF	OFF, ON	
		TOP	CONTROL	ON	OFF, ON
			RANGE		
			POSITION		
		BOTTOM	CONTROL	ON	OFF, ON
			RANGE		
			POSITION		
		LEFT	CONTROL	ON	OFF, ON
			RANGE		
	POSITION				
	RIGHT	CONTROL	ON	OFF, ON	
		RANGE			
		POSITION			
	BLEND CURVE		5	OFF, 1, 2, 3, 4, 5, 6, 7, 8, 9	
	BLACK LEVEL	CENTER, TOP, BOTTOM, LEFT, RIGHT, BORDER(TOP), BORDER(BOTTOM), BORDER(LEFT), BORDER(RIGHT)		REFERENCE, RED, GREEN, BLUE, RESET	
	PICTURE SETTING	MODE		OFF	OFF, ZOOM, TILING
		ZOOM	HORIZONTAL ZOOM		
			VERTICAL ZOOM		
			HORIZONTAL POSITION		
			VERTICAL POSITION		
		TILING	WIDTH		1 UNIT, 2 UNITS, 3 UNITS, 4 UNITS
			HEIGHT		1 UNIT, 2 UNITS, 3 UNITS, 4 UNITS
HORIZONTAL POSITION			1st UNIT, 2nd UNIT, 3rd UNIT, 4th UNIT		
MULTI SCREEN	WHITE BALANCE	MODE	OFF	OFF, ON	
		CONTRAST W			
		CONTRAST R			
		CONTRAST G			
		CONTRAST B			
		BRIGHTNESS W			
		BRIGHTNESS R			
		BRIGHTNESS G			
SETUP	MENU(1)	LANGUAGE	ENGLISH	ENGLISH, DEUTSCH, FRANÇAIS, ITALIANO, ESPAÑOL, SVENSKA, 日本語 DANSK, PORTUGUÊS, ČESTINA, MAGYAR, POLSKI, NEDERLANDS, SUOMI NORSK, TÜRKÇE, РУССКИЙ, عربي, Ελληνικά, 简体中文, 한국어 ROMÂNĂ, HRVATSKA, БЪЛГАРСКИ, INDONESIA, हिन्दी, ไทย, ភ្នំពេញ, 繁體中文, Tiếng Việt	
		COLOR SELECT	COLOR	COLOR, MONOCHROME	
		OSD BRIGHTNESS	10	1, 2, 3, 4, 5, 6, 7, 8, 9, 10	
		INPUT DISPLAY	ON	OFF, ON	
		MESSAGE DISPLAY	ON	OFF, ON	
		ID DISPLAY	ON	OFF, ON	
		DISPLAY TIME	AUTO 45 SEC	MANUAL, AUTO 5 SEC, AUTO 15 SEC, AUTO 45 SEC	

5. Using On-Screen Menu

Menu Item		Default	Options	
SETUP	MENU(2)	MENU ANGLE	0°	0°, 90°, 270°
		MENU POSITION	CENTER	TOP-LEFT, TOP-CENTER, TOP-RIGHT, CENTER-LEFT, CENTER, CENTER-RIGHT, BOTTOM-LEFT, BOTTOM-CENTER, BOTTOM-RIGHT
	INSTALLATION(1)	ORIENTATION	AUTO	AUTO, DESKTOP FRONT, CEILING REAR, DESKTOP REAR, CEILING FRONT
		SCREEN	FREE	FREE, 4:3 SCREEN, 16:9 SCREEN, 16:10 SCREEN
		SCREEN TYPE		
		POSITION		
		WALL COLOR	OFF	OFF, WHITEBOARD, BLACKBOARD, BLACKBOARD (GRAY), LIGHT YELLOW, LIGHT GREEN, LIGHT BLUE, SKY BLUE, LIGHT ROSE, PINK
		REF. LIGHT MODE	SILENT	NORMAL, SILENT, LONG LIFE
		REF. LIGHT MODE		
		REF. LIGHT ADJUST		
		CONSTANT BRIGHTNESS	OFF	OFF, ON
		REF. WHITE BALANCE		
		CONTRAST R		
		CONTRAST G		
		CONTRAST B		
		BRIGHTNESS R		
		BRIGHTNESS G		
		BRIGHTNESS B		
		STATIC CONVERGENCE		
	HORIZONTAL R			
	HORIZONTAL G			
	HORIZONTAL B			
	VERTICAL R			
	VERTICAL G			
	VERTICAL B			
	SLEEP AUDIO OUT	OFF	OFF, ON	
	INSTALLATION(2)	SHUTTER SETTINGS		
		POWER ON SHUTTER	OPEN	OPEN, CLOSE
		PICTURE MUTE SHUTTER	OPEN	OPEN, CLOSE
		FADE IN TIME	0	0–10 SEC
		FADE OUT TIME	0	0–10 SEC
		REF. LENS MEMORY		
		PROFILE	1	1, 2
STORE				
MOVE				
RESET				
LOAD BY SIGNAL		OFF	OFF, ON	
FORCED MUTE		OFF	OFF, ON	
LENS POSITION		HOME		
LENS CALIBRATION				
LENS MOVE AMOUNT				
CENTER FOCUS		3	1, 2, 3, 4, 5	
PERIPHERY FOCUS	3	1, 2, 3, 4, 5		
ZOOM	3	1, 2, 3, 4, 5		
COLOR UNIFORMITY(TOOL)	OFF	OFF, 1, 2, 3		
GAMMA(TOOL)	OFF	OFF, 1, 2, 3		

5. Using On-Screen Menu

		Menu Item			Default	Options				
SETUP	CONTROL(1)	TOOLS	ADMINISTRATOR MODE	MENU MODE		ADVANCED	ADVANCED, BASIC			
				NOT SAVE SETTING VALUES		OFF	OFF, ON			
			PROGRAM TIMER	ENABLE				OFF	OFF, ON	
				SETTINGS	EDIT	ACTIVE				
						DAY				
						TIME				
						FUNCTION				
						ADVANCED SETTINGS				
			REPEAT							
			DATE AND TIME SETTINGS	TIME ZONE SETTINGS						
		DATE AND TIME SETTINGS								
		SUMMER TIME SETTINGS								
		MOUSE	BUTTON		RIGHT HAND	RIGHT HAND, LEFT HAND				
			SENSITIVITY		MEDIUM	FAST, MEDIUM, SLOW				
		CONTROL PANEL LOCK					OFF	OFF, ON		
		COMMUNICATION SPEED			38400bps		4800bps, 9600bps, 19200bps, 38400bps, 115200bps			
		PC CONTROL(HDBaseT)					OFF	OFF, ON		
	CONTROL ID	CONTROL ID NUMBER		1		1-254				
		CONTROL ID				OFF, ON				
	REMOTE SENSOR			FRONT/BACK		FRONT/BACK, FRONT, BACK, HDBaseT				
	USER KEY	USER1				---, CONTRAST, BRIGHTNESS, SHARPNESS, COLOR, HUE, FREEZE, BLANK, MUTE, AV MUTE, AUTO ADJUST, PIP/ PBP, REF. LENS MEMORY1, REF. LENS MEMORY2, LENS CALIBRATION				
		USER2								
		USER3								
	COMMAND FORMAT			A		A, B				
	CONTROL(2)	ADMIN PASSWORD	EDIT							
			LOGOUT							
			RESET							
USER ACCOUNT		USER1/USER2/ USER3	EDIT							
			ENABLE							
			DELETE							
START-UP LOCK					OFF	OFF, ON				
SYNCHRONOUS CONTROL		MODE		OFF		OFF, MAIN, SUB				
		UNITS		4		2, 3, 4				
		IP ADDRESS MAIN/SUB1/SUB2/SUB3								
	SIGNAL MUTE		ON		OFF, ON					

5. Using On-Screen Menu

Menu Item		Default	Options		
SETUP	NETWORK SETTINGS	WIRED LAN	INTERFACE	LAN, HDBaseT	
			PROFILES	DISABLE, PROFILE 1, PROFILE 2	
			DHCP	OFF, ON	
			IP ADDRESS		
			SUBNET MASK		
			GATEWAY		
			AUTO DNS	OFF, ON	
			DNS CONFIGURATION		
		RECONNECT			
		PROJECTOR NAME	PROJECTOR NAME	pj-*****	
		DOMAIN	HOST NAME	pj-*****	
			DOMAIN NAME		
		ALERT MAIL	ALERT MAIL	OFF, ON	
			HOST NAME	pj-*****	
			DOMAIN NAME		
			SENDER'S ADDRESS		
			SMTP SERVER NAME		
			RECIPIENT'S ADDRESS 1		
			RECIPIENT'S ADDRESS 2		
			RECIPIENT'S ADDRESS 3		
		TEST MAIL			
	NETWORK SERVICE	HTTP SERVER		ON	OFF, ON, AUTH.
			PJLink	NEW PASSWORD	
				CONFIRM PASSWORD	
				CLASS	CLASS1, CLASS2
		DESTINATION			
		AMX Device Discovery	OFF	OFF, ON	
		CRESTRON	ROOMVIEW	OFF	OFF, ON
			CRESTRON CONTROL (ENABLE, CONTROLLER IP ADDRESS, IP ID)		
		Extron XTP	OFF	OFF, ON	
		PC CONTROL	ON	OFF, ON	
		AUTH. PC CONTROL	ON	OFF, ON	
		Art-Net	Art-Net	OFF	OFF, ON
			[2.x.x.x]		
			[10.x.x.x]		
			SETTINGS		
	CHANNEL				
	SOURCE OPTIONS	DEFAULT INPUT SELECT		LAST	LAST, AUTO, HDMI1, HDMI2, HDBaseT
		SEAMLESS SWITCHING		OFF	OFF, ON
		BACKGROUND		BLUE	BLUE, BLACK, LOGO
		HDBaseT OUT SELECT		OFF	OFF, AUTO, HDMI1, HDMI2, HDBaseT
		EDID VERSION	HDMI1	MODE1	MODE1, MODE2
HDMI2			MODE1	MODE1, MODE2	
HDCP VERSION		HDMI1	HDCP 2.2	HDCP 2.2, HDCP 1.4	
		HDMI2	HDCP 2.2	HDCP 2.2, HDCP 1.4	
		HDBaseT	HDCP 1.4	HDCP 2.2, HDCP 1.4	

5. Using On-Screen Menu

		Menu Item	Default	Options
SETUP	POWER OPTIONS	POWER-SAVING	ON	OFF, ON
		DIRECT POWER ON	OFF	OFF, ON
		AUTO POWER ON SELECT	OFF	OFF, HDMI1, HDMI2, HDBaseT
		AUTO POWER OFF	0:15	OFF, 0:05, 0:10, 0:15, 0:20, 0:30, 1:00
		OFF TIMER	OFF	OFF, 0:30, 1:00, 2:00, 4:00, 8:00, 12:00, 16:00
	RESET	CURRENT SIGNAL		
		ALL DATA		
		ALL DATA (INCLUDING ENTRY LIST)		
		INITIALIZE PROJECTOR		
	INFO.	USAGE TIME	LIGHT HOURS USED	
PROJECTOR HOURS USED				
TOTAL CARBON SAVINGS				
SOURCE(1)		INPUT TERMINAL		
		RESOLUTION		
		HORIZONTAL FREQUENCY		
		VERTICAL FREQUENCY		
		SYNC POLARITY		
		SCAN TYPE		
		SOURCE NAME		
		ENTRY NO.		
SOURCE(2)		SIGNAL TYPE		
		BIT DEPTH		
		VIDEO LEVEL		
		SAMPLING FREQUENCY		
SOURCE(3)		INPUT TERMINAL		
		RESOLUTION		
		HORIZONTAL FREQUENCY		
		VERTICAL FREQUENCY		
		SYNC POLARITY		
		SCAN TYPE		
		SOURCE NAME		
		ENTRY NO.		
SOURCE(4)		SIGNAL TYPE		
		BIT DEPTH		
		VIDEO LEVEL		
		SAMPLING FREQUENCY		
WIRED LAN		IP ADDRESS		
		SUBNET MASK		
		GATEWAY		
		MAC ADDRESS		
		DNS		
VERSION		SOFTWARE		
OTHERS		DATE TIME		
		PROJECTOR NAME		
		MODEL NO.		
		SERIAL NUMBER		
		CONTROL ID*6		
		LENS ID		

*6 [CONTROL ID] will be displayed when [CONTROL ID] has been set up.

5. Using On-Screen Menu

		Menu Item	Default	Options
INFO.	CONDITIONS	INTAKE TEMPERATURE		
		EXHAUST TEMPERATURE		
		ATMOSPHERIC PRESSURE		
		INSTALLATION POSITION		
		X-AXIS		
		Y-AXIS		
		Z-AXIS		
		OPTION COVER		
	HDBaseT	SIGNAL QUALITY		
		OPERATION MODE		
		LINK STATUS		
		HDMI STATUS		
	Art-Net(1)	Ch1		
		Ch2		
		Ch3		
		Ch4		
		Ch5		
		Ch6		
		Ch7		
		Ch8		
		Ch9		
	Art-Net(2)	Ch10		
		Ch11		
		Ch12		
	SYNCHRO	MAIN		
		SUB1		
		SUB2		
SUB3				

5-4. Menu Descriptions & Functions [INPUT]

HDMI1

This projects the video of the device connected to the HDMI 1 terminal.

HDMI2

This projects the video of the device connected to the HDMI 2 terminal.

HDBaseT

Projects the video of the device connected to the HDBaseT IN port.

ENTRY LIST

Displays a list of signals. See the following pages.

TEST PATTERN

Closes the menu and switches to the test pattern screen.

Using the Entry List

When any source adjustments are made, the adjustments are automatically registered in the Entry List. The (adjustment values of) registered signals can be loaded from the Entry List whenever necessary.

However, only up to 100 patterns can be registered in the Entry List. When 100 patterns have been registered in the Entry List, an error message is then displayed and no additional patterns can be registered. You should thus delete (adjustment values of) signals that are no longer needed.

ENTRY LIST					
NO.	SOURCE NAME	RESOLUTION	INPUT	🔒	🔓
001	1280x1024 60Hz	1024 x 768	HDMI1	✓	✓
002	NTSC358	1024 x 768	HDMI2	✓	✓
003	AAA	1024 x 768	HDBaseT	✓	✓
004	BBB	1024 x 768	HDMI1	✓	✓
005	005	1024 x 768	HDMI2	✓	✓
006	006	1024 x 768	HDBaseT	✓	✓
007					
008					
009					
010					
011					
012					
013					

ENTER ↘LOAD EXIT ↘EXIT ⇄:MOVE ⇄:MOVE

If the [ENTRY LIST] window is not displayed, switch the menu to [ADVANCED].

To switch the menu between [ADVANCED] and [BASIC], select [SETUP] → [CONTROL] → [TOOLS] → [ADMINISTRATOR MODE] → [MENU MODE]. (→ page 123)

Entering the currently projected signal into the Entry List [📥] (STORE)

1. Press the ▲ or ▼ button to select any number.
2. Press the ◀ or ▶ button to select [📥] (STORE) and press the ENTER button.

ENTRY LIST					
NO.	SOURCE NAME	RESOLUTION	INPUT	🔒	🔓
001	1280x1024 60Hz	1024 x 768	HDMI1	✓	✓
002	NTSC358	1024 x 768	HDMI2	✓	✓
003	AAA	1024 x 768	HDBaseT	✓	✓
004	BBB	1024 x 768	HDMI1	✓	✓
005	005	1024 x 768	HDMI2	✓	✓
006	006	1024 x 768	HDBaseT	✓	✓
007					
008					
009					
010					
011					
012					
013					

ENTER ↘SELECT EXIT ↘EXIT ⇄:MOVE ⇄:MOVE STORE

Calling up a signal from the Entry List [(LOAD)]



1. Press the ▲ or ▼ button to select a signal and press the ENTER button.

Editing a signal from the Entry List [(EDIT)]

1. Press the ▲ or ▼ button to select a signal you wish to edit.
2. Press the ◀, ▶, ▲, or ▼ button to select [ (EDIT)] and press the ENTER button.

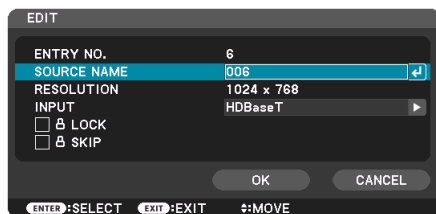
The [EDIT] window will be displayed.



SOURCE NAME	Enter a signal name. Up to 18 alphanumeric characters can be used.
INPUT	The input terminal can be changed. Switching between HDMI1/HDMI2/HDBaseT is possible.
 LOCK	Set so that the selected signal cannot be deleted when [ (ALL DELETE)] is executed. The changes made after LOCK execution cannot be saved.
 SKIP	Set so that the selected signal will be skipped during auto search.

3. Set the above items and select [OK] and press the ENTER button.

NOTE:

- The input terminal cannot be changed to the currently projected signal.

Cutting a signal from the Entry List [(CUT)]

1. Press the ▲ or ▼ button to select a signal you wish to delete.
2. Press the ◀, ▶, ▲, or ▼ button to select [ (CUT)] and press the ENTER button.

The signal will be deleted from the Entry List and the deleted signal will be displayed on the clipboard at the bottom of the Entry List.



NOTE:

- The currently projected signal cannot be deleted.
 - When the locked signal is selected, it will be displayed in gray which indicates it is not available.
-

TIP:

- Data on the clipboard can be passed onto the Entry List.
 - Data on the clipboard will not be lost after the Entry List is closed.
-

Copying and pasting a signal from the Entry List [(COPY)] / [(PASTE)]

1. Press the ▲ or ▼ button to select a signal you wish to copy.
2. Press the ◀, ▶, ▲, or ▼ button to select [ (COPY)] and press the ENTER button.
The copied signal will be displayed on the clipboard at the bottom of the Entry List.
3. Press the ◀ or ▶ button to move to the list.
4. Press the ▲ or ▼ button to select a signal.
5. Press the ◀, ▶, ▲, or ▼ button to select [ (PASTE)] and press the ENTER button.

Data on the clipboard will be pasted to the signal.

Deleting all the signals from the Entry List [(ALL DELETE)]

1. Press the ◀, ▶, ▲, or ▼ button to select [ (ALL DELETE)] and press the ENTER button.
The confirmation message will be displayed.
2. Press the ◀ or ▶ button to select [YES] and press the ENTER button.

NOTE:

- The locked signal cannot be deleted.
-

Using Test Pattern [TEST PATTERN]

Displays the test pattern for adjusting distortion on the screen and the focus at the time of the projector setup. Once the [TEST PATTERN] on the onscreen menu is selected, the pattern for adjustment will be displayed on. If you find distortion on the pattern, adjust the projector installation angle or correct distortion by pressing the Geometric. button on the remote. If the focus adjustment is required, press the FOCUS button on the remote control for displaying the [FOCUS] adjustment screen and then adjust [FOCUS] by ◀ or ▶ button. Recommend to perform the focus adjustment after leaving the projector under the state the TEST PATTERN has been projected for over 30 minutes. Press EXIT button to close the test pattern and return to the menu.

5-5. Menu Descriptions & Functions [ADJUST]

[PICTURE]

[MODE]

This function allows you to determine how to save settings for [DETAIL SETTINGS] of [PRESET] for each input.

STANDARD	Saves settings for each item of [PRESET] (Preset 1 through 7)
PROFESSIONAL	Saves all the settings of [PICTURE] for each input.

NOTE:

- When [TEST PATTERN] is displayed, [MODE] cannot be selected.

[PRESET]

This function allows you to select optimized settings for your projected image.

You can adjust neutral tint for yellow, cyan or magenta.

There are seven factory presets optimized for various types of images. You can also use [DETAIL SETTINGS] to set user adjustable settings to customize each gamma or color.

Your settings can be stored in [PRESET] 1 to [PRESET] 7.

AUTO	Automatically distinguish the optimal setting for the input signal.
HIGH-BRIGHT	Projects images at maximum brightness. Use this setting in bright locations.
PRESENTATION	Makes images brightly vivid. Use this setting when projecting content via computer signals.
VIDEO	Makes images naturally vivid. Use this setting when projecting content from televisions or general image sources.
CINEMA	Highlights the black portions of gradation patterns. Use this setting when projecting movies in dark spaces, as it is close to the DCI standard.
GRAPHIC	Enables natural reproduction with high color intensity. Use this setting when projecting photographs, pictures, signage, or other such content in dark spaces.
sRGB	Standard color values
DICOM SIM.	Recommended for DICOM simulation format.

NOTE:

- The [DICOM SIM.] option is for training/reference only and should not be used for actual diagnosis.
- DICOM stands for Digital Imaging and Communications in Medicine. It is a standard developed by the American College of Radiology (ACR) and the National Electrical Manufacturers Association (NEMA).

The standard specifies how digital image data can be moved from system to system.

[DETAIL SETTINGS]**[GENERAL]****Storing Your Customized Settings [REFERENCE]**

This function allows you to store your customized settings in [PRESET 1] to [PRESET 7]. First, select a base preset mode from [REFERENCE], then set [GAMMA SETTING] and [COLOR TEMPERATURE].

HIGH-BRIGHT	Projects images at maximum brightness. Use this setting in bright locations.
PRESENTATION	Makes images brightly vivid. Use this setting when projecting content via computer signals.
VIDEO	Makes images naturally vivid. Use this setting when projecting content from televisions or general image sources.
CINEMA	Highlights the black portions of gradation patterns. Use this setting when projecting movies in dark spaces, as it is close to the DCI standard.
GRAPHIC	Enables natural reproduction with high color intensity. Use this setting when projecting photographs, pictures, signage, or other such content in dark spaces.
sRGB	Standard color values.
DICOM SIM.	Recommended for DICOM simulation format.

Adjusting the gradation of the picture [GAMMA SETTING]

Adjusts the gradation of the picture. With this, even dark areas can be reproduced vividly.

NOTE:

- This function is not available when [DICOM SIM.] is selected for [DETAIL SETTINGS].

Selecting Screen Size for DICOM SIM [SCREEN SIZE]

This function will perform gamma correction appropriate for the screen size.

LARGE	For screen size of 300"
MEDIUM	For screen size of 200"
SMALL	For screen size of 100"

NOTE:

- This function is available only when [DICOM SIM.] is selected for [DETAIL SETTINGS].

Adjusting Color Temperature [COLOR TEMPERATURE]

This option allows you to select the color temperature of your choice. A value between 5000 K and 10500 K can be set in 100 K units.

NOTE:

- When [HIGH-BRIGHT] is selected in [REFERENCE], this function is not available.

Adjusting Brightness and Contrast [DYNAMIC CONTRAST]

Light output is automatically adjusted to match the image and provide optimal image contrast.

OFF	Dynamic contrast is disabled.
NORMAL	Normal settings.
ENHANCED	Sets the light source output adjustment to high. This creates a sharper image than NORMAL.

NOTE:

- [DYNAMIC CONTRAST] cannot be selected in the following cases.
 - When [SYNCHRONOUS CONTROL] → [MODE] is set to [SUB]
- [DYNAMIC CONTRAST] is disabled in the following cases.
 - When [CONSTANT BRIGHTNESS] is set to [ON]

[AUTO BLACK SHUTTER]

Select whether to automatically turn off the light source when a completely black signal is input.

NOTE:

- [AUTO BLACK SHUTTER] cannot be selected in the following cases.
 - When [DYNAMIC CONTRAST] is set to [OFF]
 - When [SYNCHRONOUS CONTROL] → [MODE] is set to [SUB]

Adjusting Brightness [LIGHT MODE]

Adjust the brightness of the projector and save it for each input signal.

The adjustment will be valid if the [PICTURE] → [MODE] is set to [PROFESSIONAL]. (→ page 93)

LIGHT ADJUST		Brightness can be adjusted in 1% increments. The adjustment range will vary depending on the [REF. LIGHT MODE] settings. NORMAL: 70–100% SILENT: 70–90% LONG LIFE: 60–90%
CONSTANT BRIGHTNESS	OFF	[CONSTANT BRIGHTNESS] mode will be canceled.
	ON	Maintains the brightness that is in effect at the time [ON] is selected. Unless [OFF] is selected, the same settings will remain in effect even when the projector is turned off. <ul style="list-style-type: none"> • To re-adjust the brightness, first turn this setting [OFF] before making further adjustments.
		NOTE: • The [CONSTANT BRIGHTNESS] setting will not be saved for each input signal.

NOTE:

- [LIGHT ADJUST] cannot be selected in the following cases.
 - When [WALL COLOR] is set to [WHITEBOARD]
 - When [CONSTANT BRIGHTNESS] is set to [ON]

Adjusting White Balance [WHITE BALANCE]

This allows you to adjust the white balance. Contrast for each color (RGB) to adjust the white level of the screen; Brightness for each color (RGB) is used to adjust the black level of the screen.

[COLOR CORRECTION]

Corrects the color for all signals.

Adjusts the tone for the colors red, green, blue, yellow, magenta and cyan.

RED	HUE	+ Direction	Magenta direction
		– Direction	Yellow direction
	SATURATION	+ Direction	Vivid
		– Direction	Weak
	BRIGHTNESS	+ Direction	Increase
		– Direction	Decrease
GREEN	HUE	+ Direction	Yellow direction
		– Direction	Cyan direction
	SATURATION	+ Direction	Vivid
		– Direction	Weak
	BRIGHTNESS	+ Direction	Increase
		– Direction	Decrease
BLUE	HUE	+ Direction	Cyan direction
		– Direction	Magenta direction
	SATURATION	+ Direction	Vivid
		– Direction	Weak
	BRIGHTNESS	+ Direction	Increase
		– Direction	Decrease
YELLOW	HUE	+ Direction	Red direction
		– Direction	Green direction
	SATURATION	+ Direction	Vivid
		– Direction	Weak
	BRIGHTNESS	+ Direction	Increase
		– Direction	Decrease
MAGENTA	HUE	+ Direction	Blue direction
		– Direction	Red direction
	SATURATION	+ Direction	Vivid
		– Direction	Weak
	BRIGHTNESS	+ Direction	Increase
		– Direction	Decrease
CYAN	HUE	+ Direction	Green direction
		– Direction	Blue direction
	SATURATION	+ Direction	Vivid
		– Direction	Weak
	BRIGHTNESS	+ Direction	Increase
		– Direction	Decrease

[CONTRAST]

Adjusts the intensity of the image according to the incoming signal.

[BRIGHTNESS]

Adjusts the brightness level or the back raster intensity.

[SHARPNESS]

Controls the detail of the image.

[COLOR]

Increases or decreases the color saturation level.

[HUE]

Varies the color level from +/- green to +/- blue. The red level is used as reference.

NOTE:

- When [TEST PATTERN] is displayed, [CONTRAST], [BRIGHTNESS], [SHARPNESS], [COLOR] and [HUE] cannot be adjusted.
-

[VOLUME]

Adjusts the volume level of the audio output terminals.

NOTE:

- [VOLUME] is not displayed in the [ADVANCED] menu.
-

[RESET]

The settings and adjustments for [PICTURE] will be returned to the factory default settings with the exception of the following; Preset numbers and [REFERENCE] within the [PRESET] screen.

The settings and adjustments under [DETAIL SETTINGS] within the [PRESET] screen that are not currently selected will not be reset.

[IMAGE OPTIONS]**Adjusting Horizontal/Vertical Position [HORIZONTAL/VERTICAL]**

Adjusts the image location horizontally and vertically.

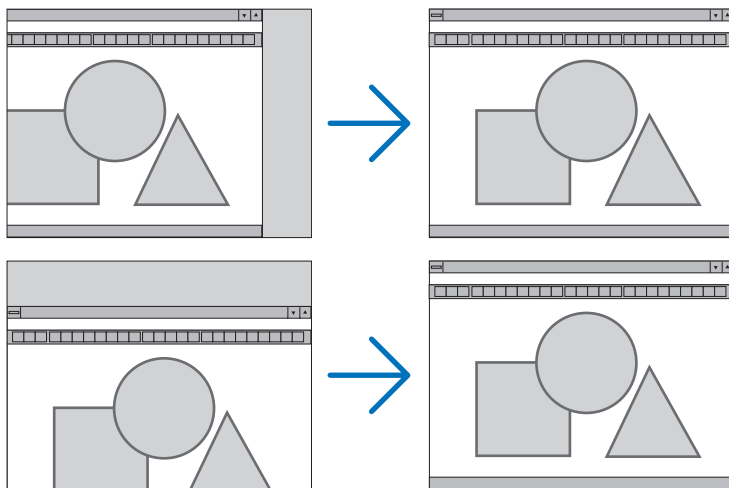
**NOTE:**

- The adjustments for [HORIZONTAL] and [VERTICAL] will be stored in memory for the current signal. The next time you project the signal with the same resolution, horizontal and vertical frequency, its adjustments will be called up and applied.
To delete adjustments stored in memory, from the menu, you select [SETUP] → [RESET] → [CURRENT SIGNAL] and reset the adjustments.

[BLANKING]

Adjusts the display range (blanking) at the top, bottom, left and right edges of the input signal.

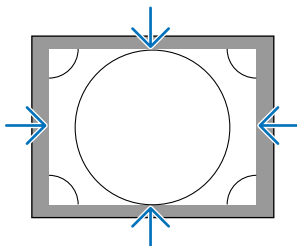

Selecting Overscan Percentage [OVERSCAN]

Select overscan percentage (Auto, 0%, 5% and 10%) for signal.

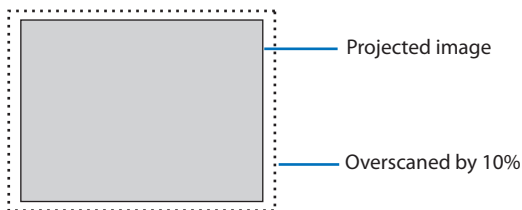

NOTE:

- The [OVERSCAN] item is not available:
 - when [NATIVE] is selected for [ASPECT RATIO].

Selecting the Aspect Ratio [ASPECT RATIO]

Use this function to select the screen's lateral:longitudinal aspect ratio.

The projector automatically identifies the signal being input and sets the optimum aspect ratio.

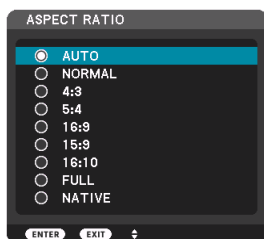

For Computer signal

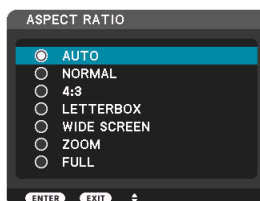

For HDTV/SDTV signals

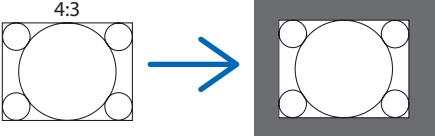
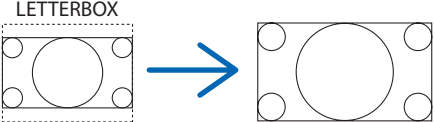
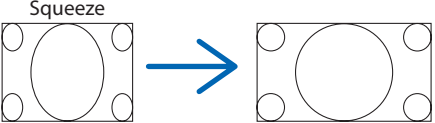

Options	Function
AUTO	The projector will automatically determine the incoming signal and display it in its aspect ratio. The projector may erroneously determine the aspect ratio depending on its signal. If this occurs, select the appropriate aspect ratio from the following.
NORMAL	The image is displayed in its original aspect ratio of its input signal.
4:3	The image is displayed in 4:3 aspect ratio.
5:4	The image is displayed in 5:4 aspect ratio
16:9	The image is displayed in 16:9 aspect ratio
15:9	The image is displayed in 15:9 aspect ratio
16:10	The image is displayed in 16:10 aspect ratio

Options	Function
NATIVE	<p>The projector displays the current image in its true resolution when the incoming signal has a lower or higher resolution than the projector's native resolution. (→ page 174)</p> <p>When the incoming signal has a higher resolution than the projector's native resolution, the center of an image will be displayed.</p> 
LETTERBOX	<p>The image of a letterbox signal (16:9) is stretched equally in the horizontal and vertical directions to fit the screen.</p> 
WIDE SCREEN	<p>The image of a squeeze signal (16:9) is stretched left and right in 16:9.</p> 
ZOOM	<p>The image of a squeeze signal (16:9) is stretched left and right in 4:3. Parts of the displayed image are cropped at the left and right edges and therefore not visible.</p> 
FULL	Project to full screen size.

TIP:

- Image position can be adjusted vertically using [POSITION] when the [16:9], [15:9], or [16:10] aspect ratios are selected.
- The term "letterbox" refers to a more landscape-oriented image when compared to a 4:3 image, which is the standard aspect ratio for a vide source.
The letterbox has aspect ratios with the vista size "1.85:1" or cinema scope size "2.35:1" for movie film.
- The term "squeeze" refers to the compressed image of which aspect ratio is converted from 16:9 to 4:3.

[VIDEO]**Using Noise Reduction [NOISE REDUCTION]**

When projecting a video image, you can use the [NOISE REDUCTION] function to reduce the screen noise (roughness and distortion). Depending on the noise level, the noise reduction effect can be set to [OFF], [LOW], [MEDIUM] or [HIGH].

Selecting Interlaced Progressive Conversion Process Mode [DEINTERLACE]

This function allows you to select an interlaced-to-progressive conversion process for video signals.

NORMAL	Automatically distinguishes a moving image from a static image to create a distinct image. Please select [MOVIE] if there are any obvious jitter and noises.
MOVIE	Select when projecting moving images. This is suitable for signals with a lot of jitter and noise.
STILL	Select when projecting static images. The video will flicker when a moving image is projected.

[SIGNAL TYPE]

Selection of RGB and component signals. Normally, this is set to [AUTO]. Please change the setting if the color of the image remains unnatural.

AUTO	Automatically distinguishes RGB and component signals.
RGB	Switches to the RGB input.
REC601	Switches to the component signal conforming to the ITU-R Rec601 standard. Setting appropriate to SDTV images.
REC709	Switches to the component signal conforming to the ITU-R Rec709 standard. Setting appropriate to Hi-Vision images.
REC2020	Switches to the component signal conforming to the ITU-R Rec2020 standard. Setting appropriate to 4K images.

[VIDEO LEVEL]

Selection of the video signal level when connecting an external device to the projector.

AUTO	The video level is switched automatically based on the information from the device outputting the signal. Depending on the connected device, this setting may not be made properly. In this case, switch to [NORMAL] or [ENHANCED] from the menu and view with the optimum setting.
NORMAL	This disables the enhanced mode.
ENHANCED	This improves the image's contrast, expressing the dark and light sections more dynamically.
SUPER WHITE	The video contrast is improved and the dark areas appear more dynamic.

[HDR MODE]

AUTO	Automatically distinguishes HDR signal.
OFF	Projects the image based on the input signal
ON	Projects the image conforming to the HDR signal

NOTE:

- These options are available exclusively for 4K signal.

Using the Lens Memory Function [LENS MEMORY]

This function serves to store the adjusted values for each input signal when using the [LENS SHIFT], [ZOOM], and [FOCUS] functions of the projector. Adjusted values can be applied to the signal you selected. This will eliminate the need to adjust lens shift, focus, and zoom at the time of source selection.

STORE	Stores the current adjusted values in memory for each input signal.
MOVE	Applies the adjusted values to the current signal.
RESET	Returns the adjusted values to the last condition.
LOAD BY SIGNAL	Moves the lens to the registered lens adjustment position when the signal is switched.
FORCED MUTE	Select whether to mute the picture or not when moving the lens.

NOTE:

- This function is not available for the lens units XP-50ZL, XP-44ML, NP50ZL and NP44ML.

TIP:

- Lens memory adjustments will be automatically registered the [ENTRY LIST]. These lens memory adjustments can be loaded from the [ENTRY LIST]. (→ page 90)
Note that performing [CUT] or [ALL DELETE] in the [ENTRY LIST] will delete lens memory adjustments as well as source adjustments. This deletion will not take effect until other adjustments is loaded.
- For storing each adjustment of [LENS SHIFT], [ZOOM], and [FOCUS] as common value for all input signal, store them as [REF. LENS MEMORY].

To store your adjusted values in [LENS MEMORY]:

1. Project the connected device signal you want to adjust.
2. Adjust the projecting image of position, size and focus by the **SHIFT/HOME POSITION**, **ZOOM +/-**, and **FOCUS +/-** buttons.
 - Adjustment can be performed by the remote control. Please refer to "Adjusting the Picture Size and Position" on page 27.
 - Slight adjustment by moving the projector position and by the tilt foot is not subject of [LENS MEMORY].
3. Move the cursor on [STORE] and press ENTER.

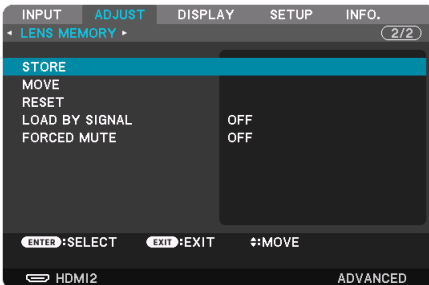

4. Move the cursor on [YES] and press ENTER.

To call up the adjusted values from [LENS MEMORY]:

1. From the menu, select [ADJUST] → [LENS MEMORY] → [MOVE] and press the ENTER button.

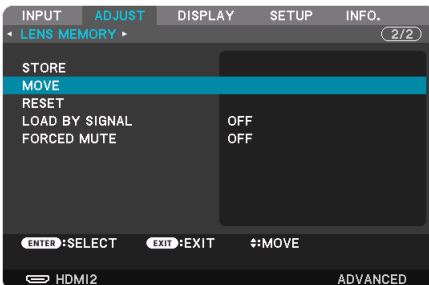

The confirmation screen will be displayed.

2. Press the ◀ button to select and [YES] and press the ENTER button.

During projection, if the adjusted values for an input signal have been saved, the lens will shift. If not, the lens will shift according to the adjusted values stored in the selected [REF. LENS MEMORY] → [PROFILE] number.

To automatically apply the adjusted values at the time of source selection:

1. From the menu, select [LOAD BY SIGNAL] and press the ENTER button.

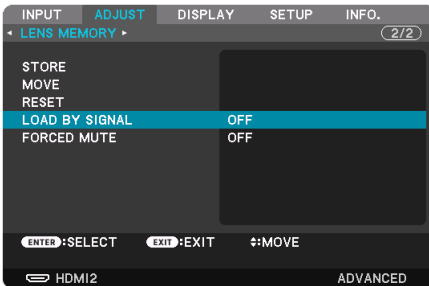

2. Press the ▼ button to select [ON] and press the ENTER button.

This will move the lens automatically to the position at the time of source selection according to the adjusted values.

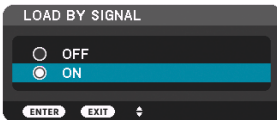

NOTE:

- The [LENS MEMORY] function may not produce a completely aligned image (due to tolerances in the lenses) using the adjusted values stored in the projector. After calling up and applying the adjusted values from the [LENS MEMORY] function, finely adjust the [LENS SHIFT], [ZOOM] and [FOCUS] to produce the best possible image.
-

5-6. Menu Descriptions & Functions [DISPLAY]

[PIP/PICTURE BY PICTURE]

SUB INPUT

Select the input signal to be displayed in the sub-display.

Please refer to “Using a single projector to project two types of videos at the same time [PIP/PICTURE BY PICTURE]” (→ page 63) for details on the operation.

MODE

Select either [PIP] (PICTURE IN PICTURE) or [PICTURE BY PICTURE] when switching to 2-screen display.

PICTURE SWAP

The videos in the main display and sub-display will be switched.

Please refer to “Using a single projector to project two types of videos at the same time [PIP/PICTURE BY PICTURE]” (→ page 63) for details.

PIP SETTING

Select the display position, position adjustment and size of the sub-display in the [PIP] screen.

START POSITION	Selection of the display position of the sub-display when switching to the [PIP] screen.
HORIZONTAL POSITION	Adjust the display position of the sub-display in the horizontal direction. The respective corners will serve as reference points.
VERTICAL POSITION	Adjust the display position of the sub-display in the vertical direction. The respective corners will serve as reference points.
SIZE	Select the display size of the sub-display.

TIP:

- The [HORIZONTAL POSITION] and [VERTICAL POSITION] are the amount of movement from the reference points. For example, when [TOP-LEFT] is adjusted, the position is displayed with the same amount of movement even if displayed with other [START POSITION] settings.

The maximum amount of movement is half the resolution of the projector.

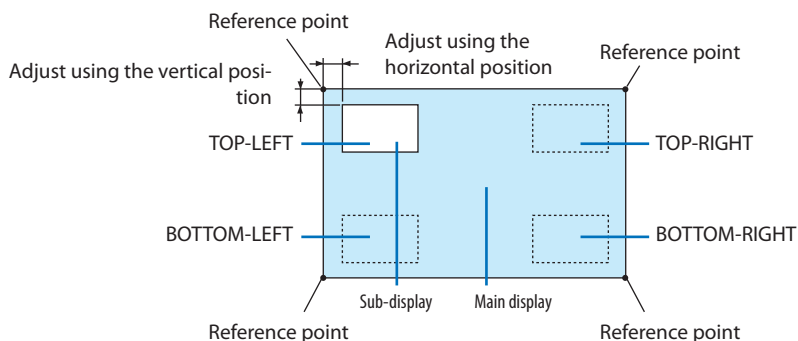

BORDER

Select the display boundary of the main display and sub-display of the [PICTURE BY PICTURE] screen.

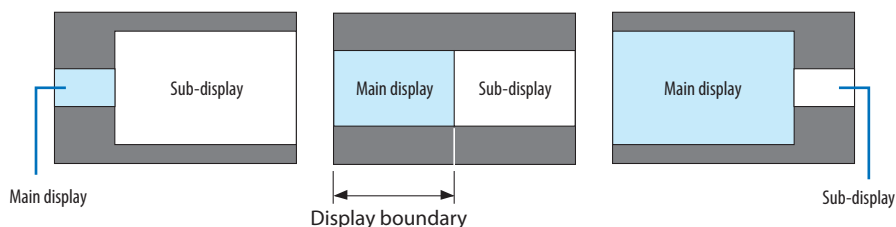

TIP:

- Seven options from zero to six are available.

[GEOMETRIC CORRECTION]**MODE**

Set pattern for correcting distortion. If [OFF] is selected, the [GEOMETRIC CORRECTION] becomes ineffective.

NOTE:

- If you need to change the [MENU ANGLE], make sure to change it before performing the [GEOMETRIC CORRECTION]. If [MENU ANGLE] is changed after performing the [GEOMETRIC CORRECTION], corrected values will be reset to the default values.

KEYSTONE

Correct distortion in horizontal and vertical directions.

HORIZONTAL	Adjustments when projecting from a diagonal direction to the screen.											
VERTICAL	Adjustments when projecting from the top or bottom direction to the screen.											
HORIZONTAL SHIFT	Adjusts the distortion when performing trapezoidal correction with the screen moved in the horizontal direction using the lens shift.											
VERTICAL SHIFT	Adjusts the distortion when performing trapezoidal correction with the screen moved in the vertical direction using the lens shift.											
THROW RATIO	Adjusts according to the projection ratio of the optional lens used.											
	<table border="1"> <thead> <tr> <th>Lens unit</th> <th>Adjustment range</th> </tr> </thead> <tbody> <tr> <td>XP-40ZL/NP40ZL</td> <td>8 - 11</td> </tr> <tr> <td>XP-41ZL/NP41ZL</td> <td>13 - 30</td> </tr> <tr> <td>XP-43ZL/NP43ZL</td> <td>30 - 60</td> </tr> <tr> <td>XP-50ZL/NP50ZL</td> <td>6 - 8</td> </tr> </tbody> </table>	Lens unit	Adjustment range	XP-40ZL/NP40ZL	8 - 11	XP-41ZL/NP41ZL	13 - 30	XP-43ZL/NP43ZL	30 - 60	XP-50ZL/NP50ZL	6 - 8	
Lens unit	Adjustment range											
XP-40ZL/NP40ZL	8 - 11											
XP-41ZL/NP41ZL	13 - 30											
XP-43ZL/NP43ZL	30 - 60											
XP-50ZL/NP50ZL	6 - 8											

NOTE:

- When power is supplied to the device, the adjustment value of the [KEystone] used previously is retained even if the gradient of the device is changed.
 - As electrical correction is carried out by [KEystone], the brightness may be reduced or the screen quality may deteriorate sometimes.
 - Some combinations of adjustment values may limit the adjustment range.
-

CORNERSTONE

Display the 4-point correction screen and adjust the trapezoidal distortion of the projection screen. Please refer to "Correcting Horizontal and Vertical Keystone Distortion [CORNERSTONE]" (→ page 44) for details on the operation.

HORIZONTAL CORNER/VERTICAL CORNER

Distortion correction for corner projection such as wall surfaces.

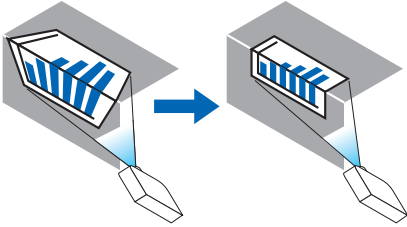
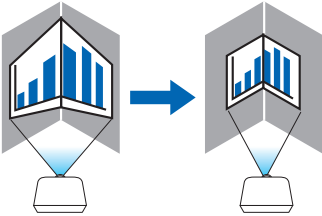
HORIZONTAL CORNER	<p>Performs correction for projection onto a wall lying at an angle to the horizontal direction.</p>  <p>* Reverse angle correction is also possible.</p>
VERTICAL CORNER	<p>Performs correction for projection onto a wall lying at an angle to the vertical direction.</p>  <p>* Reverse angle correction is also possible.</p>

NOTE:

- When the maximum adjustment range is exceeded, distortion adjustment is disabled. Set up the projector at an optimal angle as the deterioration in the image quality increases as the distortion adjustment volume gets larger.
- Please note that the image will go out of focus due to the difference in the distance between the upper and lower or left and right sides and the center of the screen for projections cutting across corners. Lenses with short focal points are also not recommended for projections cutting across corners as the image will go out of focus.

Adjustment method

1. **Align the cursor with the [HORIZONTAL CORNER] or [VERTICAL CORNER] of the [GEOMETRIC CORRECTION] menu and then press the ENTER button.**
 - The adjustment screen will be displayed.
2. **Press the ▼▲◀▶ buttons to align the cursor (blue box) with the target adjustment point and then press the ENTER button.**
 - The cursor will change into an adjustment point (blue in color).
3. **Press the ▼▲◀▶ buttons to adjust the corners or sides of the screen and then press the ENTER button.**
 - The adjustment point will go back to being a cursor (blue box).

Explanation of screen transition

- The adjustment points of the four corners (a, c, f and h in the drawing) will move independently.
- The following adjustment points differ at the [HORIZONTAL CORNER] and [VERTICAL CORNER].

HORIZONTAL CORNER: When Point b in the drawing is moved, and the upper side and Point g are moved, the lower side will move in a parallel manner.

VERTICAL CORNER: When Point d in the drawing is moved, and the left side and Point e are moved, the right side will move in a parallel manner.

[Adjustment points of the [HORIZONTAL CORNER] screen and movement points of the projection screen]

Point b will be displaced in a parallel manner at the same time as Points a, b, c

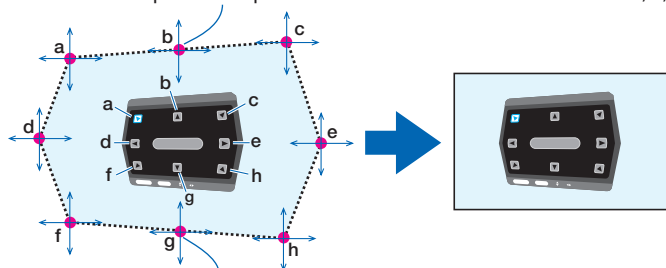

Point g will be displaced in a parallel manner at the same time as Points f, g, h

[Adjustment points of the [VERTICAL CORNER] screen and movement points of the projection screen]

Point d will be displaced in a parallel manner at the same time as Points a, d, f

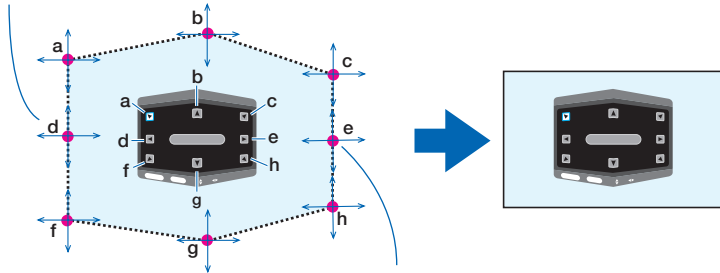

Point e will be displaced in a parallel manner at the same time as Points c, e, h

4. **Start from Step 2 onwards to adjust the other points.**
5. **When the adjustment is completed, press the ▼▲◀▶ buttons to align the cursor with the [EXIT] in the adjustment screen and then press the ENTER button.**
 - Switch to the [GEOMETRIC CORRECTION] menu screen.
6. **Press ◀ or ▶ button to move the cursor onto [OK] then press [ENTER].**
 - The adjusted values for [HORIZONTAL CORNER] or [VERTICAL CORNER] are stored and the screen display goes back to the [GEOMETRIC CORRECTION].

TIP:

- A commercially available USB mouse is available to perform correction. (→ page 48)

WARP

Correct projected image distortion on a specific surface as a column or a sphere.

NOTE:

- When the maximum adjustment range is exceeded, distortion adjustment is disabled. Set up the projector at an optimal angle since the more the adjustment volume gets large, the more image quality gets deterioration.
- Please note that the image will go out of focus due to the difference in the distance between peripheries and the center of the screen for projections cutting across corners as on a column or a sphere. Lenses with short focal points are also not recommended for projections cutting across corners as the image will go out of focus.

Adjustment method

1. **Align the cursor with the [WARP] of the [GEOMETRIC CORRECTION] menu and the press the ENTER.**
 - Adjustment screen will be displayed on.
2. **Press the ▼▲◀▶ buttons to align the cursor (blue box) with the target adjustment point and then press the ENTER.**
 - The cursor will change into an adjustment point (blue in color).
3. **Press the ▼▲◀▶ buttons to adjust the corners or sides of the screen and then press the ENTER.**
 - The cursor will back to blue box.

Explanation for correcting distortion

- Eight adjustment points can be moved independently.
- For left and right sides, use ◀/▶ buttons for adjusting the range of distortion, and ▼/▲ buttons for adjusting the distortion peak.
- For top and bottom sides, use ▼/▲ buttons for adjusting the range of distortion, and ◀/▶ buttons for adjusting the distortion peak.
- For corners, use ▼▲◀▶ buttons for moving positions.

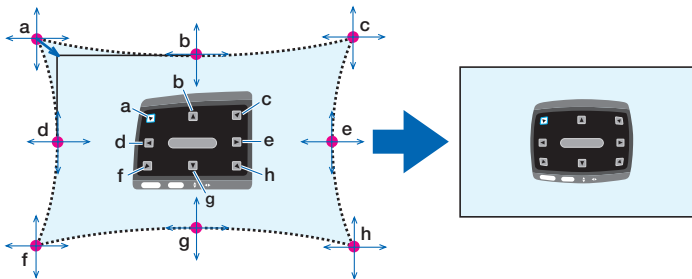

4. **For adjusting other points, repeat Step2 onwards.**
5. **When the adjustment is completed, move the cursor onto the [EXIT] on the adjustment screen and press the ENTER.**
 - The screen will be switched to the [GEOMETRIC CORRECTION] menu.
The adjustment completion screen will be displayed on.
6. **Press ◀ or ▶ button to move the cursor onto [OK] then press [ENTER].**
 - The adjusted values for [WARP] are stored and the screen display goes back to the [GEOMETRIC CORRECTION].

TIP:

- A commercially available USB mouse is available to perform correction. (→ page 48)
-

PC TOOL

Recall the geometric correction data that is registered in the projector beforehand.

Three types of correction data can be registered.

In addition, recall the geometric correction data that is registered in the projector after adjusting with the ProAssist software application.

NOTE:

- As electrical correction is carried out in geometric correction, the brightness may be affected and the picture quality may be degraded.
-

RESET

Reset the adjustment value that has been set up as [MODE] in [GEOMETRIC CORRECTION] (return to the initial value).

- This is ineffective when [MODE] is set [OFF].
- Reset can be executed by pressing and holding the Geometric. button on the remote control for over 2 seconds.

[EDGE BLENDING]

This adjusts the edges (boundaries) of the projection screen when projecting high resolution videos using a combination of several projectors in the up, down, left and right positions.

MODE

This enables or disables the [EDGE BLENDING] function.

When [MODE] is set to [ON], the [MARKER], [TOP], [BOTTOM], [LEFT], [RIGHT], [BLACK LEVEL], and [BLEND CURVE] settings can be adjusted.

MARKER

Set whether to display marker or not when adjusting the range and display position. When turned on, magenta and red markers for adjusting the range adjustment and cyan and green markers for adjusting the display position will be displayed.

TOP/BOTTOM/LEFT/RIGHT

This selects the [EDGE BLENDING] locations on the left, right, top and bottom on the screen.

The following settings can be adjusted when an item is selected. (→ page 70)

CONTROL	Enable [TOP], [BOTTOM], [LEFT], and [RIGHT] functions.
RANGE	Adjust the range (width) of the edge blending.
POSITION	Adjust the display position of the edge blending.

BLEND CURVE

Set brightness for the [EDGE BLENDING] sections. (→ page 73)

BLACK LEVEL

Adjust the black level of the [EDGE BLENDING] section. (→ page 74)

[PICTURE SETTING]

This sets the division conditions for reducing or enlarging the image area and displaying it in the desired position or for projecting using a combination of several projectors.

Please refer to "Multi-Screen Projection" (→ page 62) for details.

MODE	OFF	Use the projector in a standalone state.
	ZOOM	This adjusts the position and width of the video area that you wish to divide.
	TILING	This assigns the divided screens to the projectors.
ZOOM	HORIZONTAL ZOOM	This enlarges the video area in the horizontal direction.
	VERTICAL ZOOM	This enlarges the video area in the vertical direction.
	HORIZONTAL POSITION	This shifts the video area in the horizontal direction.
	VERTICAL POSITION	This shifts the video area in the vertical direction.
TILING	WIDTH	This selects the number of projectors to be arranged horizontally.
	HEIGHT	This selects the number of projectors to be arranged vertically.
	HORIZONTAL POSITION	This selects the position of the projector starting from the left among those arranged horizontally.
	VERTICAL POSITION	This selects the position of the projector starting from the top among those arranged vertically.

Conditions for using tiling

- All the projectors need to fulfil the following conditions.
 - The panel size must be the same
 - The projection screen size must be the same
 - The left and right ends or top and bottom ends of the projection screen must be consistent.
 - The settings for the [LEFT] and [RIGHT] of the [EDGE BLENDING] are the same
 - The settings for the [TOP] and [BOTTOM] of the [EDGE BLENDING] are the same
- If the tiling conditions are satisfied, the video screen of the projector at each installation position will be automatically extracted and projected.
- If the tiling conditions are not satisfied, adjust the video screen of the projector at each installation position using the zoom function.
- Assign a unique control ID to each projector.
 - Set the “Color setting” and “DeepColor setting” on your Blu-ray player or computer to “Auto”. Refer to the owner’s manual accompanied with your Blu-ray player or computer for more information. Connect an HDMI output signal of your Blu-ray player or computer to the first projector and then connect to the HDBaseT OUT port on the first projector to the HDBaseT IN port on the second projector, same to the sequel projectors..

Tiling setting example) Number of horizontal units = 2, Number of vertical units = 2

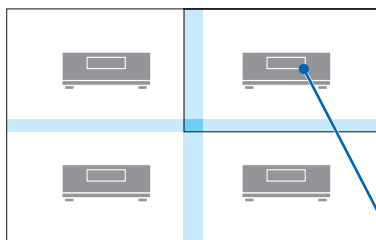

Horizontal order = Second unit
Vertical order = First unit

[MULTI SCREEN]

WHITE BALANCE

This adjusts the white balance for each projector when projecting using a combination of several projectors.

This can be adjusted when [MODE] is set to [ON].

CONTRAST W, CONTRAST R, CONTRAST G, CONTRAST B	Adjusting the white color of the video.
BRIGHTNESS W, BRIGHTNESS R, BRIGHTNESS G, BRIGHTNESS B	Adjusting the black color of the video.

5-7. Menu Descriptions & Functions [SETUP]

[MENU(1)]

Selecting Menu Language [LANGUAGE]

You can choose one of 30 languages for on-screen instructions.

Selecting Menu Color [COLOR SELECT]

You can choose between two options for menu color: [COLOR] and [MONOCHROME].

Selecting Menu Brightness [OSD BRIGHTNESS]

Select the brightness of the On-Screen display (menu, source display and messages) from 10 levels.

Turning On / Off Source Display [INPUT DISPLAY]

This option turns on or off input name display such as [HDMI1] to be displayed on the top right of the screen.

Turning messages on and off [MESSAGE DISPLAY]

This option selects whether or not to display projector messages at the bottom of the projected image.

Even when [OFF] is selected, the start-up lock warning is displayed. The start-up lock warning turns off when the start-up lock is canceled.

Turning On / Off Control ID [ID DISPLAY]

This option turns on or off the ID number which is displayed when the ID SET button on the remote control is pressed. (→ page [128](#))

Selecting Menu Display Time [DISPLAY TIME]

This option allows you to select how long the projector waits after the last touch of a button to turn off the menu. The preset choices are [MANUAL], [AUTO 5 SEC], [AUTO 15 SEC], and [AUTO 45 SEC]. The [AUTO 45 SEC] is the factory preset.

[MENU(2)]**[MENU ANGLE]**

Select the direction for displaying the menu.

[MENU POSITION]

Shift the menu displaying position. You can choose from 9 locations.

TIP:

- The display position of the menu is saved even when the power supply of the projector is turned off.
- When you change the [MENU ANGLE], the display position of the menu returns to the original state when it was first shipped from the factory.
- Input terminal and message displaying position are not influenced by the [MENU POSITION].

[INSTALLATION(1)]**Selecting Projector Orientation [ORIENTATION]**

This reorients your image for your type of projection. The options are: desktop front projection, ceiling rear projection, desktop rear projection, and ceiling front projection.

 **WARNING**

- Consult your dealer for installing the projector on the ceiling. Special skills are required for ceiling installation. Never try to install the projector yourself in such cases. The projector could drop and cause injury.

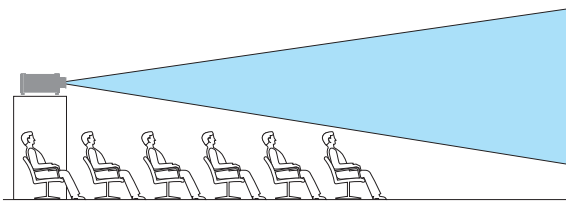
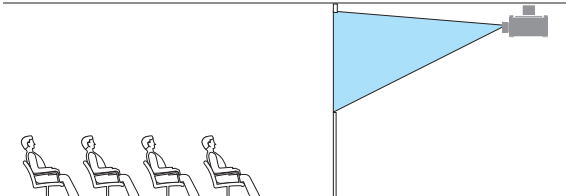
AUTO	This automatically detects and projects the [DESKTOP FRONT] and [CEILING FRONT]. NOTE: <ul style="list-style-type: none"> • The [DESKTOP REAR] and [CEILING REAR] will not be detected. Please select manually.
DESKTOP FRONT	
CEILING REAR	

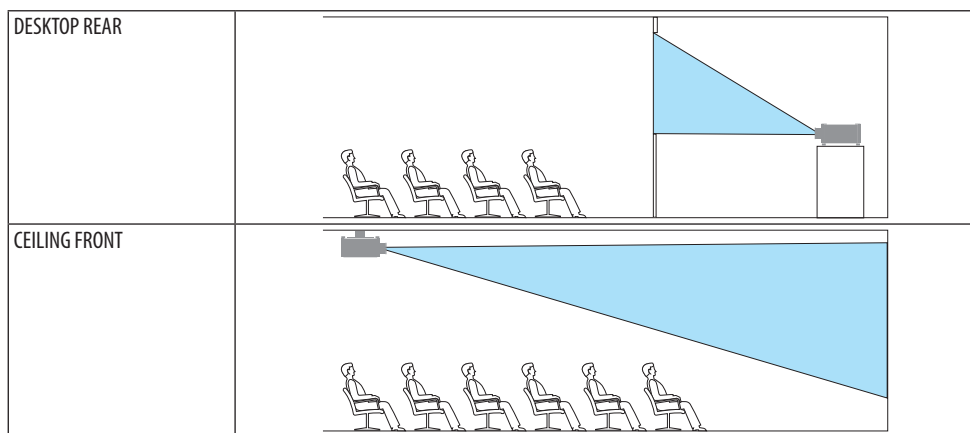
**TIP:**

- Check whether the automatic [DESKTOP FRONT] is installed within ± 10 degrees for floor installation and whether the [CEILING FRONT] is within ± 10 degrees for ceiling installation. Select manually when the projection screen is inverted.

Selecting Aspect Ratio and Position for Screen [SCREEN]**[SCREEN TYPE]**

Sets the aspect ratio of the projection screen.

FREE	The ratio of the liquid crystal panel is selected. The created screen ratio becomes the aspect screen ratio during multi-screen projection.
4:3 SCREEN	For a screen with a 4:3 aspect ratio
16:9 SCREEN	For a screen with a 16:9 aspect ratio
16:10 SCREEN	For a screen with a 16:10 aspect ratio

NOTE:

- After changing the screen type, check the setting of [ASPECT RATIO] in the menu. (→ page 99)

[POSITION]

Adjust the screen position. Depending on the model you use and the screen type, the function may become ineffective and the adjustable range may vary.

Using the Wall Color Correction [WALL COLOR]

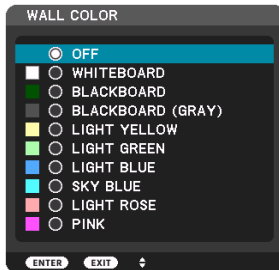

This function allows for quick adaptive color correction in applications where the screen material is not white.

NOTE:

- Selecting [WHITEBOARD] reduces light source brightness.

[REF. LIGHT MODE]

Three [REF. LIGHT MODE] options can be selected according to the purpose of use. You can also adjust output power and change luminance (brightness).

This can also be used to adjust the brightness between the different projectors when using a combination of multiple projectors.

REF. LIGHT MODE	NORMAL	This is the standard mode.
	SILENT	This mode prioritizes reducing operating noise.
	LONG LIFE	This mode prioritizes prolonging the life of the optical components.
REF. LIGHT ADJUST		The output of each [REF. LIGHT MODE] can be adjusted in 1% increments and saved. Valid when the [MODE] (→ page 93) is set to [STANDARD]. The adjustment range will vary depending on the [REF. LIGHT MODE] settings. NORMAL: 70 - 100% SILENT: 70–90% LONG LIFE: 60–90%
CONSTANT BRIGHTNESS	OFF	[CONSTANT BRIGHTNESS] mode will be canceled.
	ON	Maintains the brightness that is in effect at the time [ON] is selected. Unless [OFF] is selected, the same settings will remain in effect even when the projector is turned off. <ul style="list-style-type: none"> • To re-adjust the brightness, first turn this setting [OFF] before making further adjustments.

NOTE:

- When [WALL COLOR] is set to [WHITEBOARD], [REF. LIGHT MODE] cannot be selected.
- If [CONSTANT BRIGHTNESS] is set to [ON], then [REF. LIGHT MODE] and [REF. LIGHT ADJUST] cannot be selected.
- This function is not available for the lens units XP-50ZL, XP-44ML, NP50ZL and NP44ML.

TIP:

- Brightness normally decreases with use, but by selecting [CONSTANT BRIGHTNESS] mode, sensors inside the projector detect brightness and automatically adjust the output, thereby maintaining a constant brightness throughout the life of the light module. However, if output is already at its maximum, brightness will decrease with use. For this reason, when using multi-screen projection, it is recommended to adjust the brightness to a slightly lower level, then setting the [CONSTANT BRIGHTNESS] mode to [ON].

[REF. WHITE BALANCE]

This feature allows you to adjust the white balance for all signals. The white and black levels of the signal are adjusted for optimum color reproduction.

CONTRAST R, CONTRAST G, CONTRAST B	These adjust the picture's white color.
BRIGHTNESS R, BRIGHTNESS G, BRIGHTNESS B	These adjust the picture's black color.

[STATIC CONVERGENCE]

This feature allows you to adjust for color deviation in the picture. This can be adjusted in units of ± 1 pixel in the horizontal direction for [HORIZONTAL R], [HORIZONTAL G], and [HORIZONTAL B], in the vertical direction for [VERTICAL R], [VERTICAL G], and [VERTICAL B].

[SLEEP AUDIO OUT]

Select whether to output audio signals from the audio output terminals when the projector is in sleep mode.

[INSTALLATION(2)]**[SHUTTER SETTINGS]**

Enabling and disabling the lens shutter function.

POWER ON SHUTTER	OPEN	When the power is turned on, the light source comes on and the picture is projected.
	CLOSE	The light source does not come on when the power is turned on. When the SHUTTER button is pressed, the shutter is released and the light source is turned on.
PICTURE MUTE SHUTTER	OPEN	The light source is still on when the picture is turned off for switching the input terminals.
	CLOSE	The light source turns off when the picture is turned off for switching the input terminals.
FADE IN TIME	Set how long the light will take to fade in after the SHUTTER button is pressed. The time can be set from 0 to 10 seconds in increments of 1 second.	
FADE OUT TIME	Set how long the light will take to fade out after the SHUTTER button is pressed. The time can be set from 0 to 10 seconds in increments of 1 second.	

Using the Reference Lens Memory Function [REF. LENS MEMORY]

This function serves to store the adjusted values common to all input sources when using the [LENS SHIFT], [ZOOM], and [FOCUS] functions of the projector or the remote control. The adjusted values stored in memory can be used as a reference to the current.

PROFILE	Select a stored [PROFILE] number.
STORE	Stores the current adjusted values in memory as a reference.
MOVE	Applies the adjusted reference values stored in [STORE] to the current signal.
RESET	Reset selected [PROFILE] number [REF. LENS MEMORY] to the factory default settings.
LOAD BY SIGNAL	When you switch signals the lens will shift to the lens shift, zoom, and focus values for the selected [PROFILE] number. If no adjusted values have been saved to [LENS MEMORY], the lens will apply [REF. LENS MEMORY] adjusted values. Alternatively, if no adjusted values have been saved to [REF. LENS MEMORY], the unit will return to factory default settings.
FORCED MUTE	To turn off the image during lens shift, select [YES].

NOTE:

- This function is not available for the lens units XP-50ZL, XP-44ML, NP50ZL and NP44ML.

TIP:

- Adjusted values in [REF. LENS MEMORY] will not be returned to default when performing [CURRENT SIGNAL] or [ALL DATA] for [RESET] from the menu.
- To store adjusted values for each input source, use the Lens Memory function. (→ page 55, 102)

[LENS POSITION]

Set back the lens to the home position.

[LENS CALIBRATION]

The adjustment range of the zoom, focus, and shift of the mounted lens is calibrated. Be sure to carry out [LENS CALIBRATION] after replacing the lens.

[LENS MOVE AMOUNT]

Select one of five options to set the level of adjustment when the ◀/▶ buttons are pressed briefly while the focus and zoom adjustment screens are displayed. 1 is the smallest amount of adjustment and 5 is the maximum.

[COLOR UNIFORMITY(TOOL)]

Retrieves the uniformity adjustment value registered in the projector after adjusting with the ProAssist software application.

[GAMMA(TOOL)]

Retrieves the Gamma Tone adjustment value registered in the projector after adjusting with the ProAssist software application.

[CONTROL(1)]**[TOOLS]****ADMINISTRATOR MODE**

This allows you to select [MENU MODE], save settings, and set a password for the administrator mode.

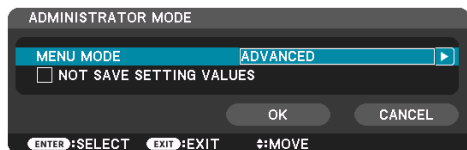

MENU MODE	Select either [BASIC] or [ADVANCED] menu. (→ page 81)	—
NOT SAVE SETTING VALUES	Placing a check mark will not save your projector settings. Clear this check box to save your projector settings.	—

PROGRAM TIMER

This option turns on/standby the projector and changes video signals, and selects [LIGHT MODE] automatically at a specified time.

Important:

- Before using [PROGRAM TIMER], make sure that the [DATE AND TIME SETTINGS] feature is set. (→ page 127)
Make sure that the projector is in the standby condition with the POWER cord connected.
The projector has a built-in clock. The clock will keep working for about a month after the main power is turned off. If the main power is not supplied to the projector for a month or more, it requires to set [DATE AND TIME SETTINGS] feature again.

Setting a new program timer

1. On the [PROGRAM TIMER] screen, use the ▲ or ▼ button to select [SETTINGS] and press the ENTER button.



The [PROGRAM LIST] screen will be displayed.

2. Select a blank program number and press the ENTER button.

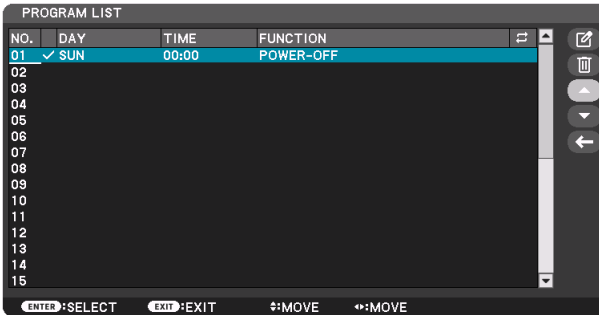

The [] (EDIT) screen will be displayed.

3. Make settings for each item as required.

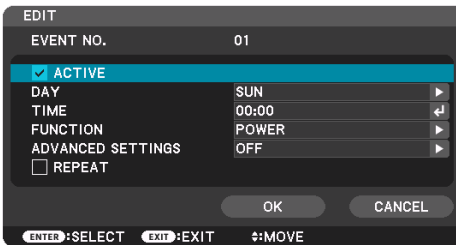

ACTIVE	Place a check mark to enable the program.
DAY	Select days of the week for the program timer. To execute the program from Monday to Friday, select [MON-FRI]. To execute the program in everyday basis, select [EVERY DAY].
TIME	Set the time to execute the program. Enter time in 24-hour format.
FUNCTION	Select a function to be executed. Selecting [POWER] will allow you to turn on or off the projector by setting [ADVANCED SETTINGS]. Selecting [INPUT] will allow you to select an input terminal by setting [ADVANCED SETTINGS]. Selecting [LIGHT MODE] will allow you to select one option among [NORMAL], [SILENT], and [LONG LIFE] for [LIGHT MODE] by setting [ADVANCED SETTINGS].
ADVANCED SETTINGS	Select one option for the selected item in [FUNCTION].
REPEAT	Place a check mark to repeat the program continuing basis. To use the program this week only, clear the check mark.

4. Select [OK] and press the ENTER button.

This will complete the settings.

You will be returned to the [PROGRAM LIST] screen.

5. Select [**←** (BACK)] and press the ENTER button.

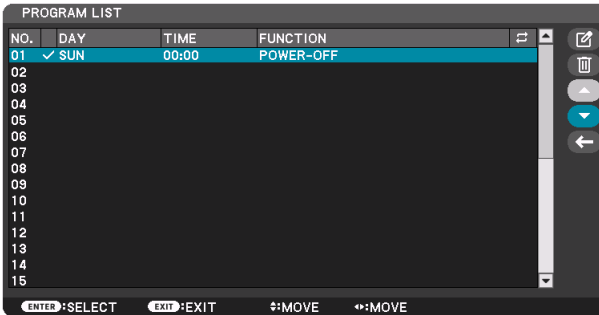

You will be returned to the [PROGRAM TIMER] screen.

6. Select [EXIT] and press the ENTER button.

You will be returned to the [TOOLS] screen.

NOTE:

- Up to 30 different timer settings can be programmed.
- The Program Timer is executed on a set time basis, not in a program basis.
- Once the program not marked with a check in [REPEAT] has been executed, the check mark in the [ACTIVE] check box will be cleared automatically and the program will be disabled.
- When the on-time and the off-time set for the same time, the off-time setting will take preference.
- When two different sources are set for the same time, the larger program number will take preference.
- The on-time setting will not be executed while the cooling fans are running or an error is occurring.
- If the off-time setting is expired under the condition in which the power off is not possible, the off-timer setting will not be executed until the power off becomes possible.
- Programs not marked with a check mark in [ACTIVE] of the [EDIT] screen will not be executed even if the Program Timer is enabled.
- When the projector is turned on by using the program timer and if you want to turn off the projector, set the off-time or do it manually so as not to leave the projector on for a long period of time.

Activating the program timer

1. Select [ENABLE] on the [PROGRAM TIMER] screen and press the ENTER button.

The selection screen will be displayed.

2. Press the ▼ button to align the cursor with [ON] and then press the ENTER button.

Return to the [PROGRAM TIMER] screen.

NOTE:

- When the effective settings of the [PROGRAM TIMER] have not been set to [ON], the program will not be executed even if the [ACTIVE] items in the [PROGRAM LIST] have been ticked.
- Even when the effective settings of the [PROGRAM TIMER] are set to [ON], the [PROGRAM TIMER] will not work until the [PROGRAM TIMER] screen is closed.

Editing the programmed settings

1. On the [PROGRAM LIST] screen, select a program you want to edit and press the ENTER button.
2. Change the settings on the [EDIT] screen.
3. Select [OK] and press the ENTER button.
The programmed settings will be changed.
You will be returned to the [PROGRAM LIST] screen.

Changing the order of programs

1. On the [PROGRAM LIST] screen, select a program whose order you want to change and press the ► button.
2. Press the ▼ button to select ▲ or ▼.
3. Press the ENTER button a few times to select a row to which you wish to move the program.
The order of the programs will be changed.

Deleting the programs

1. On the [PROGRAM LIST] screen, select a program number you want to delete and press the ► button.
2. Press the ▼ button to select  (DELETE).
3. Press the ENTER button.
The confirmation screen will be displayed.
4. Select [YES] and press the ENTER button.
The program will be deleted.

This will complete deleting the program.

DATE AND TIME SETTINGS

You can set the current time, month, date, and year.

NOTE:

- The projector has a built-in clock. The clock will keep working for about a month after the main power is turned off. If the main power is off for a month or more, the built-in clock will cease. If the built-in clock ceases, set the date and time again. The built-in clock will not cease while in the standby mode. In order to activate the built-in clock continuously even when the projector is not used, leave it in the standby state not plugging off the power cord.

TIME ZONE SETTINGS	Select your time zone.
DATE AND TIME SETTINGS	Set your current date (MM/DD/YYYY) and time (HH:MM). INTERNET TIME SERVER: If you place a check mark, the projector's built-in clock will be synchronized with an Internet time server in every 24 hours and at the time of projector's startup. UPDATE: Synchronizes the projector's built-in clock immediately. The [UPDATE] button is not available unless the [INTERNET TIME SERVER] check box is turned on.
SUMMER TIME SETTINGS	If you place a check mark, the clock for daylight saving will be enabled.

MOUSE

This function is for using a commercially available USB mouse via the USB-A port on this projector.

BUTTON	Select for using the mouse either by right or left hand.
SENSITIVITY	Select the sensitivity of mouse among [FAST], [MEDIUM] and [SLOW].

NOTE:

- This setting is not guaranteed motion of all commercially available USB mouses.

Disabling the Cabinet Buttons [CONTROL PANEL LOCK]

This option turns on or off the [CONTROL PANEL LOCK] function.

NOTE:

- How to cancel the [CONTROL PANEL LOCK]
When the [CONTROL PANEL LOCK] is set to [ON], press the EXIT button on the cabinet for 10 seconds or longer to cancel the [CONTROL PANEL LOCK] setting.

TIP:

- When the [CONTROL PANEL LOCK] is turned on, a key lock icon [] will be displayed at the bottom right of the menu.
- This [CONTROL PANEL LOCK] does not affect the remote control functions.

Selecting Communication Speed [COMMUNICATION SPEED]

This feature sets the communication speed for the PC Control port (D-Sub 9P). Make sure to set the appropriate speed for the device to connect.

[PC CONTROL(HDBaseT)]

Set this to [ON] when controlling the projector from a computer using RS-232C via an HDBaseT-compatible transmitter (sold separately).

Setting ID to the Projector [CONTROL ID]

You can operate multiple projectors separately and independently with the single remote control that has the [CONTROL ID] function. If you assign the same ID to all the projectors, you can conveniently operate all the projectors together using the single remote control. To do so, you have to assign an ID number to each projector.

CONTROL ID NUMBER	Select a number from 1 to 254 you wish to assign to your projector.
CONTROL ID	Select [OFF] to turn off the [CONTROL ID] setting and select [ON] to turn on the [CONTROL ID] setting.

NOTE:

- When [ON] is selected for [CONTROL ID], the projector cannot be operated by using the remote control that does not support the [CONTROL ID] function. (In this case the buttons on the projector cabinet can be used.)
- Pressing and holding the ENTER button on the projector cabinet for 10 seconds will display the menu for canceling the Control ID.

Assigning or Changing the Control ID

1. Turn on the projector.
2. Press the ID SET button on the remote control.

The [CONTROL ID] screen will be displayed.



If the projector can be operated with the current remote control ID, the [ACTIVE] will be displayed. If the projector cannot be operated with the current remote control ID, the [INACTIVE] will be displayed. To operate the inactive projector, assign the control ID used for the projector by using the following procedure (Step 3).

3. Press one of numeric keypad buttons while pressing and holding the ID SET button on the remote control.

Example:

To assign "3", press the "3" button on the remote control.

No ID means that all the projectors can be operated together with a single remote control. To set "No ID" and cancel the control ID setting, enter "000" or press the number 0 while holding down the ID SET button.

TIP:

- The range of IDs is from 1 to 254.

4. Release the ID SET button.

The updated [CONTROL ID] screen will be displayed.

NOTE:

- The IDs can be cleared in a few days after the batteries are run down or removed.
- Accidentally pressing any one of the buttons of the remote control will clear currently specified ID with batteries removed.

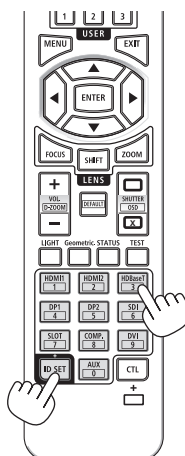
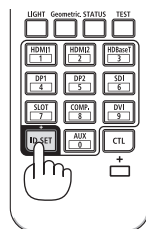

Turning On or Off Remote Sensor [REMOTE SENSOR]

This option determines which remote sensor on the projector is enabled in wireless mode. The options are: [FRONT/BACK], [FRONT], [BACK], and [HDBaseT].

NOTE:

- The remote control of the projector will not be able to receive signals if the power supply of the HDBaseT transmission device connected to the projector is switched on when this has been set to [HDBaseT].

TIP:

- If the remote control system does not function when direct sunlight or strong illumination strikes the remote control sensor of the projector, change to other option.

[USER KEY]

Selects the functions to assign to the USER1/2/3 buttons on the remote. Select “---” to disable a function.

Available functions

CONTRAST, BRIGHTNESS, SHARPNESS, COLOR, HUE	Adjust the projected image. (→ page 97)
FREEZE	Changes the projected video to a still image. Press the button again to resume.
BLANK	Temporarily erases the image. Press the button again to restore.
MUTE	Temporarily mutes the audio. Press the button again to unmute.
AV MUTE	Temporarily mutes the image and audio. Press the button again to unmute.
AUTO ADJUST	Automatically adjusts the projected image to the optimal condition.
PIP/PBP	Select [SUB INPUT] to project two images simultaneously.
REF. LENSMEMORY1	Reads the adjustment values for [PROFILE1] in [REF. LENS MEMORY]and automatically adjusts lens shift, zoom, and focus. (→ page 121)
REF. LENSMEMORY2	Reads the adjustment values for [PROFILE2] in [REF. LENS MEMORY]and automatically adjusts lens shift, zoom, and focus. (→ page 121)
LENS CALIBRATION	Calibrates the adjustment range of the mounted lens. (→ page 122)

TIP:

- The default setting for the USER1 button is [AUTO ADJUST].
- The [USER KEY] function is set on the projector side. When operating multiple projectors with one remote, every projector must have the same assigned [USER KEY] functions.

[COMMAND FORMAT]

Connecting a computer to the projector's PC CONTROL port switches the control command format. (→ page 188)

[CONTROL(2)]**[ADMIN PASSWORD]**

Set the password for the projector administrator.

If you set the administrator's password, the confirmation screen will be displayed when you set the following items. You must enter the password.

On-screen menu: [ADMINISTRATOR MODE], [START-UP LOCK], [ADMIN PASSWORD], [USER ACCOUNT], [NETWORK SETTINGS], and [INITIALIZE PROJECTOR]

HTTP server: [NETWORK] tab and [LOGO] tab

EDIT	Set the password. Perform the setting using 5 to 16 characters (letters or numbers). NOTE: <ul style="list-style-type: none"> • Make a note of your password and store it in a safe place.
LOGOUT	Logs you out of the logged in status with the ADMIN PASSWORD.
RESET	Cancels the ADMIN PASSWORD. Inform your dealer of the cancellation code displayed on the reset code input screen ("XXXX-XXXX-XXXXXXXX-XXXX-XXXX"; X being letters or numbers). Input the reset code you have been informed in return to cancel the ADMIN PASSWORD.

NOTE:

- When you enter the password, pay enough attention to people around for the password abuse prevention.
If you have anxiety the password is cheated, change the password immediately.

TIP:

- If you are logged in with the ADMIN PASSWORD, the "👤" icon is displayed at the bottom of the menu screen.
- You will be automatically logged out if no button is operated for 30 minutes while you are logged in.

[USER ACCOUNT]

Up to three user accounts for use with [HTTP SERVER] authentication and [AUTH. PC CONTROL] can be registered.

EDIT	<p>Set the user name and password. Perform the setting using 5 to 16 characters (letters or numbers).</p> <p>NOTE:</p> <ul style="list-style-type: none"> • Make a note of your password and store it in a safe place.
ENABLE	<p>Choose whether to enable or disable the user account. [ON] will enable the user account. [OFF] will disable the user account. With this user account, you cannot connect to an HTTP server that requires authentication or operate the projector using the [AUTH. PC CONTROL] function.</p>
DELETE	<p>Delete the USER NAME and PASSWORD that have been set at [USER ACCOUNT].</p> <p>NOTE:</p> <ul style="list-style-type: none"> • If the [USER1], [USER2], and [USER3] accounts have all been deleted, you cannot connect to the HTTP server that requires authentication or operate the projector using the [AUTH. PC CONTROL] function.

NOTE:

- When you enter the password, pay enough attention to people around for the password abuse prevention.
If you have anxiety the password is cheated, change the password immediately.

Enabling Security [START-UP LOCK]

This feature turns on or off the [START-UP LOCK] function.

Unless the correct keyword is entered, the projector cannot project an image. (→ page 49)

[SYNCHRONOUS CONTROL]

When projecting from multiple projectors (multi-screen projection, stack projection, etc.), all the projectors can be operated simultaneously with a single remote control (→ page 76). The projector set as the main projector controls the sub-projectors connected by HDBaseT daisy chain (→ page 160) or wired LAN (→ page 161).

Synchronized functions: POWERON/OFF, AV MUTE, SHUTTER OPEN/CLOSE, SIGNAL MUTE, DYNAMIC CONTRAST, AUTO BLACK SHUTTER

When the main projector settings are configured, the sub-projectors are notified of the [MODE], [IP ADDRESS] - [MAIN], and [SIGNAL MUTE] settings and synchronous control is enabled.

MODE	OFF: [SYNCHRONOUS CONTROL] is disabled. MAIN, SUB: These set the main and sub-projectors. Only one projector can be set as the main projector.
UNITS	Select the total number of projectors for which the [SYNCHRONOUS CONTROL] function is to be set, (2, 3 or 4).
IP ADDRESS	[For the main projector] MAIN: The main projector's IP address is displayed. SUB1, 2 and 3: The sub-projectors' IP addresses are displayed.
	[For the sub-projectors] MAIN: Set the main projector's IP address. SUB1, 2 and 3: The IP addresses for the sub-projectors are displayed. They cannot be changed.
SIGNAL MUTE	Selects whether or not to mute (turn off) the picture and sound when the input terminal or the signal is switched. This is set on the main projector.

NOTE:

- When [WIRED LAN] → [PROFILES] is set to [DISABLE], [MODE] cannot be selected.
- When [PIP/PICTURE BY PICTURE] → [SUB INPUT] is set to anything other than [OFF], [SIGNAL MUTE] cannot be selected.
- Depending on the connected devices and the status of the input signal, muting could take an extremely long time, repeat, or not occur simultaneously. When connected in a daisy chain, we recommend switching to the wired LAN connection (→ page 161). If any of the above issues occurs with a wired LAN connection, set [SIGNAL MUTE] to [OFF].
- If the sub-projector settings are changed after making the [SYNCHRONOUS CONTROL] settings, perform this operation on the sub-projector.

[NETWORK SETTINGS]

Configure the various settings when using the projector connected to a network.

Important:

- Consult with your network administrator about these settings.
- When using a wired LAN, connect the LAN cable to the LAN port on the projector. (→ page 159)
- Please use a shielded twisted pair (STP) cable of Category 5e or higher for the LAN cable (sold commercially).
- The default [WIRED LAN] setting of this projector is set to [DISABLE] when it is shipped from the factory. To connect to a network, change the [WIRED LAN] profile setting from [DISABLE] to [PROFILE 1] or [PROFILE 2] to enable the wired LAN.

Hints on How to Set Up LAN Connection

To set up the projector for a LAN connection:

Select [WIRED LAN] → [PROFILES] → [PROFILE 1] or [PROFILE 2].

Two settings can be set for wired LAN.

Next turn on or off for [DHCP], [IP ADDRESS], [SUBNET MASK], and [GATEWAY] and select [OK] and press the ENTER button. (→ page 135)

To recall LAN settings stored in the profile number:

Select [PROFILE 1] or [PROFILE 2] for wired LAN, and then select [OK] and press the ENTER button. (→ page 135)

To connect a DHCP server:

Turn on [DHCP] for wired LAN. Select [ON] and press the ENTER button. To specify IP address without using the DHCP server, turn off [DHCP]. (→ page 135)

To receive error messages via e-mail:

Select [ALERT MAIL], and set [SENDER'S ADDRESS], [SMTP SERVER NAME], and [RECIPIENT'S ADDRESS]. Last, select [OK] and press the ENTER button. (→ page 136)

[WIRED LAN]

INTERFACE	Select [LAN] for using the LAN port for connecting to the wired LAN. Select [HDBaseT] for using the HDBaseT IN port for connecting to the wired LAN.	—
PROFILES	<ul style="list-style-type: none"> The settings for the wired LAN can be recorded in the projector memory in two ways. Select [PROFILE 1] or [PROFILE 2] and then do settings for [DHCP] and the other options. After doing this, select [OK] and press the ENTER button. This will store your settings in memory. To recall the settings from memory: After selecting [PROFILE 1] or [PROFILE 2] from the [PROFILES] list. Select [OK] and press the ENTER button. Select [DISABLE] when not connecting to a wired LAN 	—
DHCP	Place a check mark to automatically assign an IP address to the projector from your DHCP server. Clear this check box to register the IP address or subnet mask number obtained from your network administrator.	—
IP ADDRESS	Set your IP address of the network connected to the projector when [DHCP] is turned off.	Up to 12 numeric characters
SUBNET MASK	Set your subnet mask number of the network connected to the projector when [DHCP] is turned off.	Up to 12 numeric characters
GATEWAY	Set the default gateway of the network connected to the projector when [DHCP] is turned off.	Up to 12 numeric characters
AUTO DNS	Place a check mark to automatically assign the IP address of your DNS server connected to the projector from your DHCP server. Clear this check box to set the IP address of your DNS server connected to the projector.	Up to 12 numeric characters
DNS CONFIGURATION	Set the IP address of your DNS server on the network connected to the projector when [AUTO DNS] is cleared.	Up to 12 numeric characters
RECONNECT	Retry to connect the projector to a network. Try this if you have changed [PROFILES].	—

[PROJECTOR NAME]

PROJECTOR NAME	Set a unique projector name.	Up to 16 alphanumeric characters and symbols
----------------	------------------------------	--

[DOMAIN]

Set a host name and domain name of the projector.

HOST NAME	Set a host name of the projector.	Up to 16 alphanumeric characters
DOMAIN NAME	Set a domain name of the projector.	Up to 60 alphanumeric characters

[ALERT MAIL]

ALERT MAIL	<p>This option will notify your computer of error messages via e-mail when using wireless or wired LAN. Placing a checkmark will turn on the Alert Mail feature. Clearing a checkmark will turn off the Alert Mail feature. Sample of a message to be sent from the projector:</p> <table border="1"> <tr> <td> <p>Subject: [Projector] Projector Information THE COOLING FAN HAS STOPPED. [INFORMATION] PROJECTOR NAME: xxxxx LIGHT HOURS USED: xxxxx[H]</p> </td> </tr> </table>	<p>Subject: [Projector] Projector Information THE COOLING FAN HAS STOPPED. [INFORMATION] PROJECTOR NAME: xxxxx LIGHT HOURS USED: xxxxx[H]</p>	—
<p>Subject: [Projector] Projector Information THE COOLING FAN HAS STOPPED. [INFORMATION] PROJECTOR NAME: xxxxx LIGHT HOURS USED: xxxxx[H]</p>			
HOST NAME	Type in a host name.	Up to 16 alphanumeric characters	
DOMAIN NAME	Type in a domain name of the network connected to the projector.	Up to 60 alphanumeric characters	
SENDER'S ADDRESS	Specify the sender's address.	Up to 60 alphanumeric characters and symbols	
SMTP SERVER NAME	Type in the SMTP server name to be connected to the projector.	Up to 60 alphanumeric characters	
RECIPIENT'S ADDRESS 1, RECIPIENT'S ADDRESS 2, RECIPIENT'S ADDRESS 3	Type in your recipient's address.	Up to 60 alphanumeric characters and symbols	
TEST MAIL	<p>Send a test mail to check if your settings are correct.</p> <hr/> <p>NOTE:</p> <ul style="list-style-type: none"> • If you entered an incorrect address in a test, you may not receive an Alert mail. Should this happen, check if the Recipient's Address is correctly set. • Unless any one of the [SENDER'S ADDRESS], [SMTP SERVER'S NAME] or [RECIPIENT'S ADDRESS 1-3] is selected, [TEST MAIL] is not available. • Be sure to highlight [OK] and press the ENTER button before executing [TEST MAIL]. 	—	

[NETWORK SERVICE]

HTTP SERVER	<p>Configure the settings for connecting to the HTTP server.</p> <table border="1"> <tr> <td>ON</td> <td>Connect directly to the HTTP server without displaying the login screen.</td> </tr> <tr> <td>OFF</td> <td>It is not possible to connect to the HTTP server.</td> </tr> <tr> <td>AUTH.</td> <td>Display the login screen when connecting to the HTTP server.</td> </tr> </table> <p>Enter the USER NAME and PASSWORD that have been set at [USER ACCOUNT].</p>	ON	Connect directly to the HTTP server without displaying the login screen.	OFF	It is not possible to connect to the HTTP server.	AUTH.	Display the login screen when connecting to the HTTP server.	—
ON	Connect directly to the HTTP server without displaying the login screen.							
OFF	It is not possible to connect to the HTTP server.							
AUTH.	Display the login screen when connecting to the HTTP server.							

PJLink	<p>Configure the settings for using PJLink.</p> <table border="1" data-bbox="269 185 852 389"> <tr> <td data-bbox="269 185 381 300">NEW PASSWORD, CONFIRM PASSWORD</td> <td data-bbox="385 185 852 300">Set the password.</td> </tr> <tr> <td data-bbox="269 304 381 331">CLASS</td> <td data-bbox="385 304 852 331">Switches between Class 1 and Class 2.</td> </tr> <tr> <td data-bbox="269 336 381 389">DESTINATION</td> <td data-bbox="385 336 852 389">When the [CLASS] is set to [CLASS2], input the IP address of the destination.</td> </tr> </table> <p>NOTE:</p> <ul style="list-style-type: none"> Do not forget your password. However, if you forget your password, consult with your dealer. What is PJLink? PJLink is a standardization of protocol used for controlling projectors of different manufacturers. This standard protocol is established by Japan Business Machine and Information System Industries Association (JBMA) in 2005. 	NEW PASSWORD, CONFIRM PASSWORD	Set the password.	CLASS	Switches between Class 1 and Class 2.	DESTINATION	When the [CLASS] is set to [CLASS2], input the IP address of the destination.	Up to 32 alphanumeric characters
NEW PASSWORD, CONFIRM PASSWORD	Set the password.							
CLASS	Switches between Class 1 and Class 2.							
DESTINATION	When the [CLASS] is set to [CLASS2], input the IP address of the destination.							
AMX Device Discovery	<p>Turn on or off for detection from AMX Device Discovery when connecting to the network supported by AMX's NetLinX control system.</p> <p>TIP:</p> <ul style="list-style-type: none"> When using a device that supports AMX Device Discovery, all AMX NetLinX control system will recognize the device and download the appropriate Device Discovery Module from an AMX server. <p>[ON] will enable detecting the projector from AMX Device Discovery. [OFF] will disable detecting the projector from AMX Device Discovery.</p>	—						
CRESTRON	<p>ROOMVIEW: Turn on or off when controlling the projector from your PC. CRESTRON CONTROL: Turn on or off when controlling the projector from your controller.</p> <ul style="list-style-type: none"> CONTROLLER IP ADDRESS: Enter your IP address of CRESTRON SERVER. IP ID: Enter your IP ID of CRESTRON SERVER. <p>TIP:</p> <ul style="list-style-type: none"> The CRESTRON settings are required only for use with CRESTRON ROOMVIEW. For more information, visit https://www.crestron.com 	Up to 12 numeric characters						
Extron XTP	<p>Set for connecting this projector to the Extron XTP transmitter. [ON] will enable to connect with the XTP transmitter. [OFF] will disable to connect with the XTP transmitter.</p>	—						
PC CONTROL	<p>Set the PC control function to on or off. [ON] will enable the PC control function. [OFF] will disable the PC control function.</p>	—						

AUTH. PC CONTROL	<p>Set PC control function using authentication to on or off. [ON] will enable the PC control function with authentication using the user name and password registered at [USER ACCOUNT]. [OFF] will disable the PC control function with authentication.</p> <hr/> <p>NOTE:</p> <ul style="list-style-type: none"> This function is for future expansion. Security can be improved by using together with an application compatible with the authentication function. For the specifications related to the required authentication procedure using the application software, please see the "Control Command Authentication Flow Specifications" for your projector, uploaded on our website. https://www.sharp-nec-displays.com/dl/en/pj_manual/lineup.html 	—								
Art-Net	<p>Art-Net is a communication protocol for transmitting and receiving DMX512 over an Ethernet network. Configure the settings for controlling the projector using the Art-Net controller.</p> <table border="1" data-bbox="269 588 848 882"> <tr> <td data-bbox="269 588 423 619">Art-Net</td> <td data-bbox="423 588 848 619">Turns on or off Art-Net.</td> </tr> <tr> <td data-bbox="269 619 423 708">[2.X.X.X], [10.X.X.X]</td> <td data-bbox="423 619 848 708">Automatically calculates the IP address according to the Art-Net specifications and overwrites it to the current wired LAN settings (IP address, subnet mask).</td> </tr> <tr> <td data-bbox="269 708 423 767">SETTINGS</td> <td data-bbox="423 708 848 767">Sets DMX Universe and start channel used by the projector.</td> </tr> <tr> <td data-bbox="269 767 423 882">CHANNEL</td> <td data-bbox="423 767 848 882">Selects projector functions to be assigned to channels 1 thru 12. To temporarily disable the assigned function, select [LOCK] to set the parameter to a non-operable value.</td> </tr> </table> <ul style="list-style-type: none"> Art-Net is an Ethernet protocol invented by Artistic Licence. The function and DMX value set for each channel can be checked in [INFO]. See "List of Art-Net DMX parameters" (→ page 192) for the DMX parameters. 	Art-Net	Turns on or off Art-Net.	[2.X.X.X], [10.X.X.X]	Automatically calculates the IP address according to the Art-Net specifications and overwrites it to the current wired LAN settings (IP address, subnet mask).	SETTINGS	Sets DMX Universe and start channel used by the projector.	CHANNEL	Selects projector functions to be assigned to channels 1 thru 12. To temporarily disable the assigned function, select [LOCK] to set the parameter to a non-operable value.	—
Art-Net	Turns on or off Art-Net.									
[2.X.X.X], [10.X.X.X]	Automatically calculates the IP address according to the Art-Net specifications and overwrites it to the current wired LAN settings (IP address, subnet mask).									
SETTINGS	Sets DMX Universe and start channel used by the projector.									
CHANNEL	Selects projector functions to be assigned to channels 1 thru 12. To temporarily disable the assigned function, select [LOCK] to set the parameter to a non-operable value.									

[SOURCE OPTIONS]**Selecting Default Source [DEFAULT INPUT SELECT]**

You can set the projector to default to any one of its inputs each time the projector is turned on.

LAST	Sets the projector to default to the previous or last active input each time the projector is turned on.
AUTO	Searches for an active source in order of HDMI1 → HDMI2 → HDBaseT and displays the first found source.
HDMI1	Displays the digital source from the HDMI 1 connector.
HDMI2	Displays the digital source from the HDMI 2 connector.
HDBaseT	Displays the digital source from the HDBaseT IN port.

[SEAMLESS SWITCHING]

When the input connector is switched, the image displayed before switching is held to switch to the new image without a break due to absence of a signal.

Selecting a Color or Logo for Background [BACKGROUND]

Use this feature to display a blue/black screen or logo when no signal is available. The default background is [BLUE].

By factory default, a black screen is registered for [LOGO]. Register the logo image by connecting to the HTTP server from a web browser. (→ Page 54)

NOTE:

- Even when the background logo is selected, if two pictures are displayed in [PIP/PICTURE BY PICTURE] mode, the blue background is displayed without the logo when there is no signal.

[HDBaseT OUT SELECT]

Select signal to output from the HDBaseT OUT port on the projector.

OFF	No signal is output.
AUTO	Output the input signal. When two images are projected simultaneously (PIP/PICTURE BY PICTURE), the image for the main screen is output.
HDMI1	Output the input signal thru the HDMI 1 terminal.
HDMI2	Output the input signal thru the HDMI 2 terminal.
HDBaseT	Output the input signal thru the HDBaseT IN port.

NOTE:

- If the set input terminals for main and sub screen for [PIP] and [PICTURE BY PICTURE] are differed from the selected input terminals, any image will be output.
- This cannot be output when projecting 4K60p and 4K50p signals.

[EDID VERSION]

Switch the EDID version for the HDMI 1 and HDMI 2 terminals.

MODE1	Supports general signal
MODE2	Supports 4K signal Select this mode for displaying 4K image using the device supporting 4K

NOTE:

- If image and sound can not be output in [MODE2], switch to [MODE1].
-

[HDCP VERSION]

Switch the HDCP version for the HDMI 1, HDMI 2 and HDBaseT IN terminals.

HDCP 2.2	Automatically switch the mode HDCP 2.2 and HDCP 1.4
HDCP 1.4	Forcedly perform transmission with HDCP 1.4

NOTE:

- If image and sound can not be output from the monitor connected with the HDBaseT OUT port, switch the HDCP version to HDCP 1.4.
-

[POWER OPTIONS]**[POWER-SAVING]**

Select the standby mode:

ON	This setting is to keep the standby power consumption to the minimum necessary. The standby state changes automatically depending on the projector settings and the state and duration of connected devices (→ page 182). The consumption power also changes according to the standby state.
OFF	This is a setting with no functional restrictions during standby. To maintain the sleep state, the power consumption is higher than when this mode is set to [ON].

TIP:

- Even if [POWER-SAVING] is set to [ON], the projector goes to sleep in the following cases.
 - [PC CONTROL(HDBaseT)] is set to [ON]
 - [REMOTE SENSOR] is set to [HDBaseT]
 - [HDBaseT OUT SELECT] is set to other than [OFF]
 - When [AUTO POWER ON SELECT] is set to something other than [OFF] and a signal is being input to the HDMI1 or HDMI2 terminal
 - [WIRED LAN] → [INTERFACE] is set to [HDBaseT]
 - [Extron XTP] is set to [ON]
 - [SYNCHRONOUS CONTROL] → [MODE] is set to [MAIN] or [SUB]
 - While the lens is moving
 - When a temperature error or other error has occurred
- [POWER-SAVING] ON/OFF does not affect the carbon meter's calculation of the amount of CO₂ emission reduction.

Enabling Direct Power On [DIRECT POWER ON]

Turns the projector on automatically when the power cord is inserted into an active power outlet. This eliminates the need to always use the POWER button on the remote control or projector cabinet.

**WARNING**

- The projector produces intense light. When turning on the power, make sure no one within the projection range is looking at the lens.

Turning On the Projector by Detecting Input Signal [AUTO POWER ON SELECT]

Under the state of standby or sleep, the projector automatically detects and projects synchronizing signal input from the selected terminals among [HDMI1], [HDMI2], and [HDBaseT] by this function.

OFF	[AUTO POWER ON SELECT] function becomes inactive.
HDMI1, HDMI2, HDBaseT	When the projector detects the signal input from the selected terminal, automatically it will be turned [ON] and will project the screen.

WARNING

- The projector produces intense light. When the power is turned on, make sure no one within the projection range is looking at the lens.

NOTE:

- If you want to activate this [AUTO POWER ON SELECT] function after powering OFF the projector, interrupt the signal from the input terminals or disconnect the computer cable from the projector and wait for more than 3 seconds (1 minute or longer if the input signal is HDBaseT) and then the input signal from the selected terminal. In addition, if signal is continuously input to the projector, the projector may be turned ON again automatically based on the setting of external devices even if the projector is turned OFF and in the condition of SLEEP mode.
- When the projector is in standby, only the HDMI 1 or HDMI 2 input signals will be detected and projected.

Enabling Power Management [AUTO POWER OFF]

When this option is selected you can enable the projector to automatically turn off (at the selected time: 0:05, 0:10, 0:15, 0:20, 0:30, 1:00) if there is no signal received by any input or if no operation is performed.

Using Off Timer [OFF TIMER]

1. Select your desired time between 30 minutes and 16 hours: OFF, 0:30, 1:00, 2:00, 4:00, 8:00, 12:00, 16:00.
2. Press the ENTER button on the remote control.
3. The remaining time starts counting down and it is displayed at the bottom of the On-Screen Menu.
4. The projector will turn off after the countdown is complete.

NOTE:

- To cancel the preset time, set [OFF] for the preset time or turn off the power.
- When the remaining time reaches 3 minutes before the projector is turned off, the [THE PROJECTOR WILL TURN OFF WITHIN 3 MINUTES.] message will be displayed on the bottom of the screen.

Returning to Factory Default [RESET]

The [RESET] feature allows you to change adjustments and settings to the factory preset for a (all) source (s) except the following:

[CURRENT SIGNAL]

Resets the adjustments for the current signal to the factory preset levels.

The items that can be reset are: [PRESET], [CONTRAST], [BRIGHTNESS], [COLOR], [HUE], [SHARPNESS], [ASPECT RATIO], [HORIZONTAL], [VERTICAL], [CLOCK], [PHASE], and [OVERSCAN].

[ALL DATA]

Reset the adjustments and settings for all the signals to the factory preset.

All items can be reset EXCEPT [ENTRY LIST], [GEOMETRIC CORRECTION], [EDGE BLENDING], [PICTURE SETTING], [MULTI SCREEN], [LANGUAGE], [SCREEN], [REF. WHITE BALANCE], [STATIC CONVERGENCE], [SLEEP AUDIO OUT], [REF. LENS MEMORY], [LENS MOVE AMOUNT], [COLOR UNIFORMITY(TOOL)], [GAMMA(TOOL)], [ADMINISTRATOR MODE], [DATE AND TIME SETTINGS], [CONTROL PANEL LOCK], [START-UP LOCK], [COMMUNICATION SPEED], [PC CONTROL(HDBaseT)], [CONTROL ID], [USER KEY], [COMMAND FORMAT], [ADMIN PASSWORD], [USER ACCOUNT], [SYNCHRONOUS CONTROL], [NETWORK SETTINGS], [BACKGROUND], [EDID VERSION], [HDCP VERSION], [POWER-SAVING], [OFF TIMER], [LIGHT HOURS USED], [PROJECTOR HOURS USED], and [TOTAL CARBON SAVINGS].

[ALL DATA (INCLUDING ENTRY LIST)]

Reset the adjustments and settings for all the signals including the [ENTRY LIST] to the factory preset except [GEOMETRIC CORRECTION], [EDGE BLENDING], [PICTURE SETTING], [MULTI SCREEN], [LANGUAGE], [SCREEN], [REF. WHITE BALANCE], [STATIC CONVERGENCE], [SLEEP AUDIO OUT], [REF. LENS MEMORY], [LENS MOVE AMOUNT], [COLOR UNIFORMITY(TOOL)], [GAMMA(TOOL)], [ADMINISTRATOR MODE], [DATE AND TIME SETTINGS], [CONTROL PANEL LOCK], [START-UP LOCK], [COMMUNICATION SPEED], [PC CONTROL(HDBaseT)], [CONTROL ID], [USER KEY], [COMMAND FORMAT], [ADMIN PASSWORD], [USER ACCOUNT], [SYNCHRONOUS CONTROL], [NETWORK SETTINGS], [BACKGROUND], [EDID VERSION], [HDCP VERSION], [POWER-SAVING], [OFF TIMER], [LIGHT HOURS USED], [PROJECTOR HOURS USED], and [TOTAL CARBON SAVINGS].

Also deletes all the signals in the [ENTRY LIST] and returns to the factory preset.

NOTE:

- Locked signals in Entry List cannot be reset.
-

[INITIALIZE PROJECTOR]

Reset all the adjustments and settings including passwords and network settings to the factory preset except [LIGHT HOURS USED], [PROJECTOR HOURS USED], and [TOTAL CARBON SAVINGS].

NOTE:

- Personally identifiable information, such as IP addresses, may be saved on the projector.

Before transferring or disposing of the projector, clear this data by performing [INITIALIZE PROJECTOR] on the on-screen menu.

5-8. Menu Descriptions & Functions [INFO.]

[USAGE TIME]

LIGHT HOURS USED (H)	PROJECTOR HOURS USED (H)
TOTAL CARBON SAVINGS [kg-CO2]	

- The value of [LIGHT HOURS USED] reflects the temperature of the operating environment and the [LIGHT MODE] setting in the actual operating time.
- [PROJECTOR HOURS USED]
This displays the actual operating time of the projector.
- [TOTAL CARBON SAVINGS]
This displays the estimated carbon saving information in kg. The carbon footprint factor in the carbon saving calculation is based on the OECD. (→ page 43)

[SOURCE(1)]

INPUT TERMINAL	RESOLUTION
HORIZONTAL FREQUENCY	VERTICAL FREQUENCY
SYNC POLARITY	SCAN TYPE
SOURCE NAME	ENTRY NO.

[SOURCE(2)]

SIGNAL TYPE	BIT DEPTH
VIDEO LEVEL	SAMPLING FREQUENCY

[SOURCE(3)]

INPUT TERMINAL	RESOLUTION
HORIZONTAL FREQUENCY	VERTICAL FREQUENCY
SYNC POLARITY	SCAN TYPE
SOURCE NAME	ENTRY NO.

[SOURCE(4)]

SIGNAL TYPE	BIT DEPTH
VIDEO LEVEL	SAMPLING FREQUENCY

[WIRED LAN]

IP ADDRESS	SUBNET MASK
GATEWAY	MAC ADDRESS
DNS	

[VERSION]

SOFTWARE	
----------	--

[OTHERS]

DATE TIME	PROJECTOR NAME
MODEL NO.	SERIAL NUMBER
CONTROL ID*	LENS ID

• Even if an NP model lens unit is installed, the XP model will be displayed in [LENS ID].

* [CONTROL ID] will be displayed when [CONTROL ID] has been set up.

[CONDITIONS]

INTAKE TEMPERATURE	EXHAUST TEMPERATURE
ATMOSPHERIC PRESSURE	INSTALLATION POSITION
X-AXIS	Y-AXIS
Z-AXIS	OPTION COVER

About the [X-AXIS], [Y-AXIS], and [Z-AXIS] under [CONDITIONS]

* Arrow direction of the Z-AXIS in the figure represents the top of the projector.

X-AXIS:

Display the projector image at an angle of -100 – $+100$ degrees to the horizontal in the X-axis direction.

X-AXIS value of
the projector

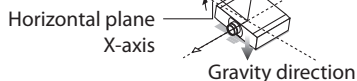
**Y-AXIS:**

Display the projector image at an angle of -100 – $+100$ degrees to the horizontal in the Y-axis direction.

Y-AXIS value of
the projector

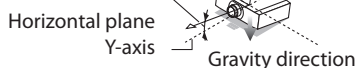
**Z-AXIS:**

Display the projector image at an angle of -100 – $+100$ degrees to the vertical in the Z-axis direction.

Z-AXIS value of
the projector

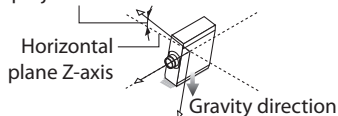

About [OPTION COVER]

This is used to check whether the option cover (separately sold) needs to be attached when the projector is installed at an angle.

- / -	Option cover is not required
A / -	Only option cover A needs to be attached
- / B	Only option cover B needs to be attached
A / B	Both of option covers A and B need to be attached

[HDBaseT]

SIGNAL QUALITY	OPERATION MODE
LINK STATUS	HDMI STATUS

The [HDBaseT] page displays the HDBaseT IN port's connection status.

SIGNAL QUALITY	Indicates the signal's quality level. NORMAL: The signal quality level is normal. WARNING: The quality level is one at which noise may be generated in the picture. ABNORMAL: The quality level is abnormal, so the picture will be disturbed or may not display.
OPERATION MODE	Indicates the connection and operation status. HDBaseT: Connected and operating in the HDBaseT mode. ETHERNET: Connected and operating in the ETHERNET mode. LOW POWER: Operating in the low power consumption mode. DISCONNECT: There is no connection.
LINK STATUS	Indicates the connection link status. HDBaseT: Signals are being exchanged in the HDBaseT mode. ETHERNET: Signals are being exchanged in the ETHERNET mode. LOW POWER: Communications have been interrupted (operating in the low power consumption mode). NO LINK: Communications cannot be established.
HDMI STATUS	Indicates the status of the HDMI signal. HDMI ON: The signal is not protected by HDCP. HDCP ON: The signal is protected by HDCP. NO HDMI: There is no signal.

[Art-Net(1)]

Ch1	Ch2	Ch3
Ch4	Ch5	Ch6
Ch7	Ch8	Ch9

[Art-Net(2)]

Ch10	Ch11	Ch12
------	------	------

[SYNCHRO]

MAIN	SUB1	SUB2	SUB3
------	------	------	------

6. Attachment/detachment of parts sold separately

6-1. Lens unit

Five separate bayonet style lenses can be used with this projector. The descriptions here are for the XP-41 ZL lens. Mount other lenses in the same manner.

After installing or replacing the lens unit, press the ZOOM/L-CALIB. button on the projector to carry out [LENS CALIBRATION]. By carrying out [LENS CALIBRATION], the adjustment range of the lens shift is calibrated.

WARNING:

(1) Turn off the power and wait for the cooling fan to stop, (2) disconnect the power cord and wait for the unit to cool before mounting or removing the lens. Failure to do so can result in eye injury, electric shock, or burn injuries.

Important:

- The projector and lenses are made of precision parts. Do not subject them to shock or excessive forces.
- Remove the separately sold lens when moving the projector. If not, the lens could be subject to shock while the projector is being moved, damaging the lens and the lens shift mechanism.
- When dismounting the lens from the projector, return the lens position to the home position before turning off the power. Failure to do so may prevent the lens from being mounted or dismounted because of narrow space between the projector and the lens.
- Never touch the lens surface while the projector is operating.
- Be very careful not to let dirt, grease, etc., on the lens surface and not to scratch the lens surface.
- Perform these operations on a flat surface over a piece of cloth, etc., to prevent the lens from getting scratched.
- When leaving the lens off the projector for long periods of time, mount the dust cap on the projector to prevent dust or dirt from getting inside.
- Always use the included support kit to secure the projector and lens unit after affixing the XP-50ZL/NP50ZL. Please refer to the XP-50ZL/NP50ZL Installation Manual for details.
- Always use the support kit (XP-02LK/NP02LK, sold separately) to secure the projector and lens unit after affixing the XP-44ML/NP44ML. Please refer to the support kit's Instruction Manual for details.

Mounting

1. Remove the dust cap from the projector.

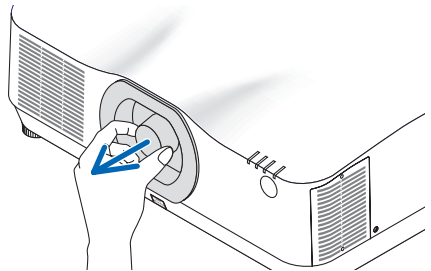

2. Remove the lens cap on the back of the lens.

NOTE:

- Make sure to remove the lens cap at the unit back side. If the lens unit with the lens cap remaining on is installed on the projector, it may cause of malfunction.

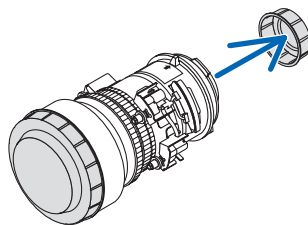

3. Align the protrusion on the lens with the guiding notch on the projector lens hole and insert the lens.

- The arrow mark in the label attached to the lens shows the position of protrusion. Insert the lens slowly all the way in.

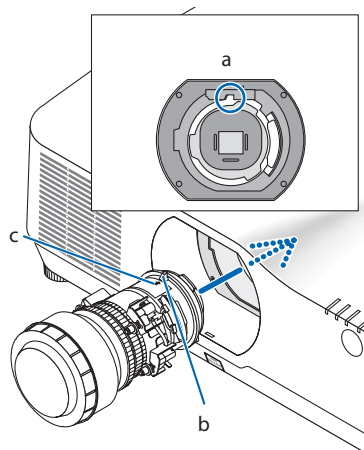

a: Guiding notch / b: Protrusion / c: Arrow

4. Turn the lens clockwise.

NOTE:

- Do not press the lens release button at the bottom of the lens mounting section when attaching the lens unit. You will not be able to fix the lens unit in the correct position.

Turn until a click is heard.

The lens is now fastened onto the projector.

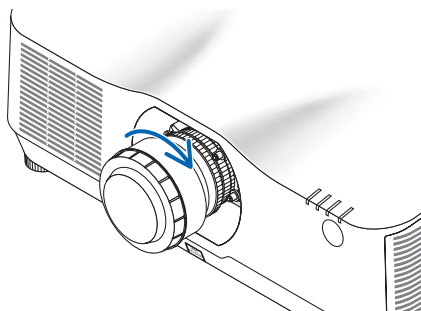

5. Mount the lens theft prevention screw.

Fasten the lens theft prevention screw included with the projector to the bottom of the projector so that the lens cannot be removed easily.

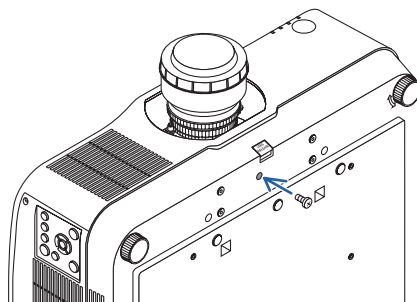

TIP:

- Attach the enclosed lens mask if you want to hide the gap between the projector and lens. The lens mask cannot be attached when using the XP-44ML/ NP44ML lens unit.

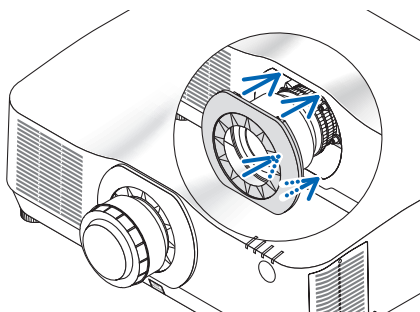

Removing

Preparations:

1. Turn on the projector and display an image.
2. Press and hold the SHIFT/HOME POSITION button over 2 seconds. The lens position will be moved to the home position.
3. Turn off the projector, and then unplug the power cord.
4. Mount the lens cap on the lens.
5. Wait until the projector cabinet is cool enough to handle.
6. Remove the lens mask if one is fitted.

6. Attachment/detachment of parts sold separately

1. Remove the lens theft prevention screw.

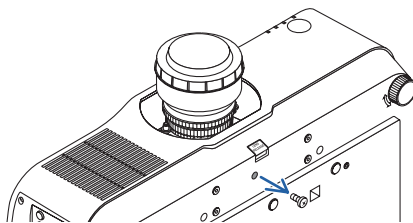

2. While pressing the lens release button at the bottom of lens mounting section on the projector's front panel fully in, turn the lens counterclockwise.

The lens comes off.

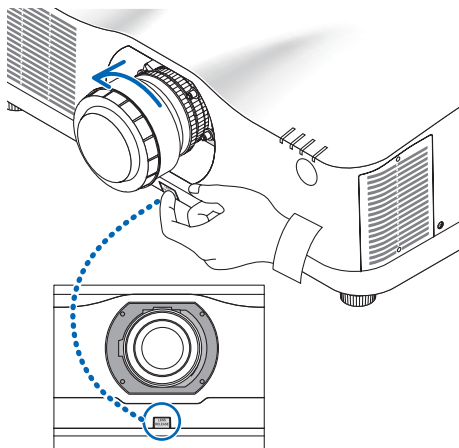

3. Slowly pull the lens off the projector.

- After removing the lens, mount the lens caps (front and back) included with the lens before storing the lens.
- If no lens is going to be mounted on the projector, mount the dust cap included with the projector.

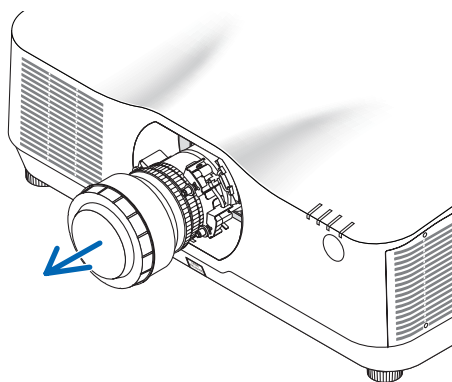

6-2. Cable cover



Model name of cable cover

XP-13CV-W for A104U-W/A824U-W

XP-13CV-B for A104U-B/A824U-B

The option covers A and B are packaged with the cable cover XP-13CV-W and XP-13CV-B.

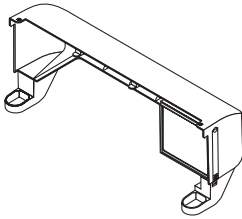
For the following cases, attach the separately sold option cover to the projector.

<p>Option cover A</p> <ul style="list-style-type: none"> To make the appearance clean by covering the connected cables To install the projector with its rear upward or downward 	
<p>Option cover B</p> <ul style="list-style-type: none"> To install the projector with its exhaust vents upward or downward 	

For installation angles required to attach the option cover, refer to page [xxx](#).

WARNING

- For tilted installation of the projector, depending on the angle, be sure to attach the separately sold option cover for safety. Using without the option cover violates safety regulations. Also, powering the projector on without the option cover installed could result in a fire.
- Do not put bundled cables in the option cover. Doing so may damage the power cord, resulting in a fire.

CAUTION

- After attaching the option cover to the projector, be sure to tighten the screws. If you fail to do so, the option cover may come off and cause injury, or the option cover may fall and cause damage.
- Do not move the projector by holding the option cover or do not use excessive force to the option cover. Doing so can cause damage to the option cover, resulting in injury.

Preparations:

- Connect the cables to the projector (the connection cords are omitted from the diagrams). At this moment, do not connect the power cord.
- Prepare a Phillips screwdriver.
- Place the projector on a soft cloth so as not to scratch the cabinet surface.

• Option cover A

Mounting

1. Remove the two corner caps from the projector.

- Keep the removed corner caps for future use.

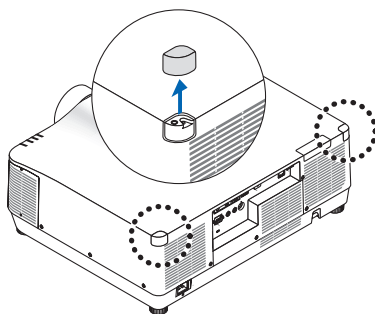

2. Turn over the projector.

CAUTION

- For moving the projector, make sure you have at least two people. Attempting to move the projector alone could result in back pain or other injuries.

3. Attach the option cover A to the projector.

- ① Shorten the projector tilt foot to the minimum height.
- ② Hang the two hooks of the option cover A on the projector tilt foot.
- ③ Align the two screw fixing parts of the option cover A with the place of the corner caps that were removed at step 1.

At this time, the two hooks in the option cover will enter the grooves in the projector.

- If the hooks do not enter easily, check the positions of the grooves. Do not press the hooks in by force.
- Be careful not to let the cables get pinched by the option cover A.

4. Turn the two option cover A screws clockwise.

- Tighten the screws securely.

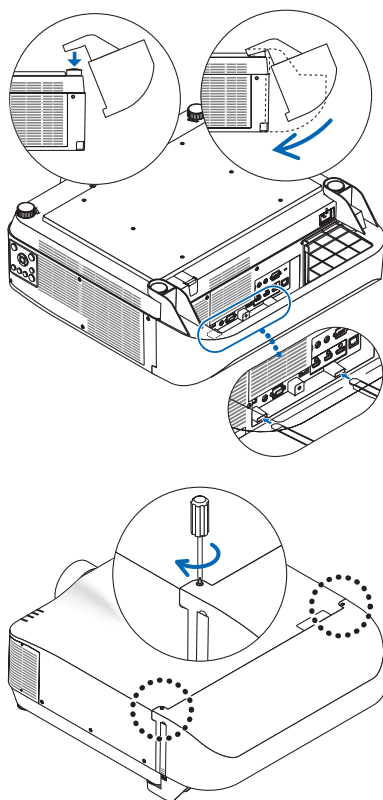

Removing

1. Turn the two option cover A screws counterclockwise until it turns loosely.

- The screws are not removable.

2. Remove the option cover A.

Hold up the option cover A to release its two hooks from projector tilt foot.

3. Attach the two corner caps to the projector.

• Option cover B

Mounting

1. Press the two protrusions on option cover B against the slits in the projector's exhaust vent.

- Line up the upper protrusion with the slit at the very top, the lower protrusion with the slit at the very bottom.

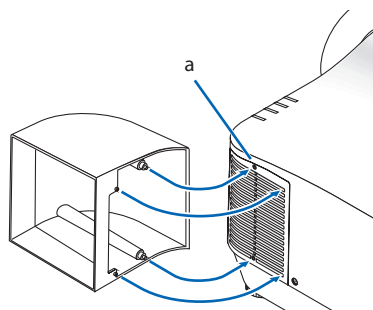

a: Screw hole

2. Supporting option cover B by hand, turn the two screws clockwise to tighten them.

- Tighten the screws securely.

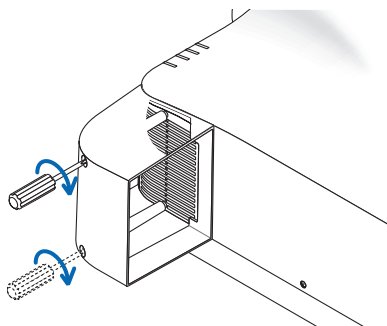

Removing

1. Supporting option cover B by hand, turn the two screws counterclockwise to loosen them until they turn freely.

- The screws are not removable.

2. Remove the option cover B.

7. Connecting to Other Equipment



CAUTION

- Be sure to turn off the projector before connecting the projector to an external device. If projected light enters your eyes, it may cause visual impairment.

NOTE:

- The connection cable is not enclosed with the projector. Please get ready a suitable cable for the connection. For HDMI, LAN, RS-232C, and AUDIO, please use a shielded signal cable. Use of other cables and adapters may cause interference with radio and television reception.
-

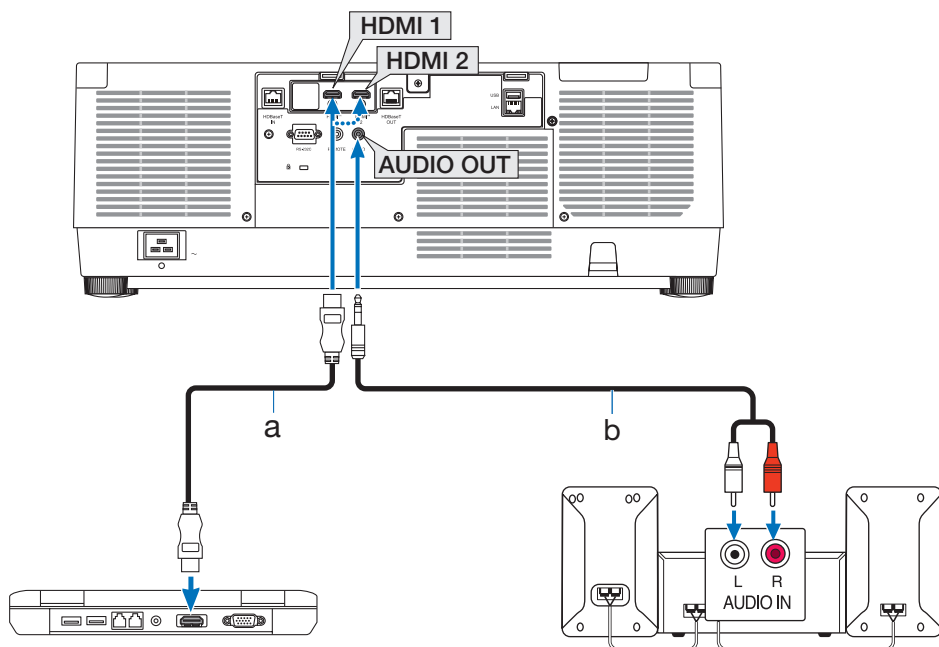

7-1. Connecting Your Computer

- Connect a commercially available HDMI cable between the computer's HDMI output connector and the projector's HDMI 1 or HDMI 2 connector.



a: HDMI cable (not supplied) / b: Audio cable (not supplied)

- Select the source name for its appropriate input connector after turning on the projector.

Input connector	INPUT button on the projector cabinet	Button on the remote control
HDMI 1	 HDMI1	HDMI1
HDMI 2	 HDMI2	HDMI2

Cautions when connecting an HDMI cable

- Use a Premium High Speed HDMI Cable.

7-2. Connecting audio video equipment

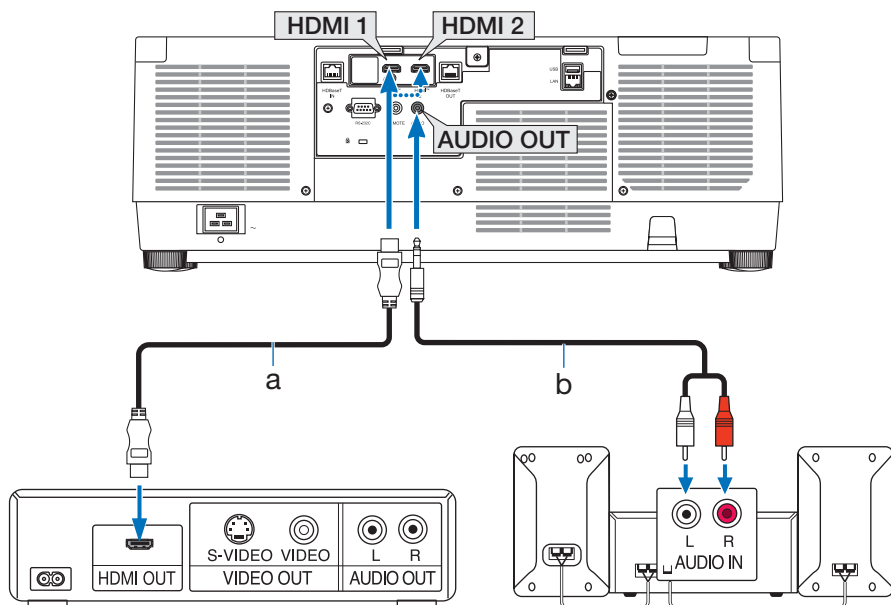

You can connect the HDMI output of your Blu-ray player, hard disk player, or notebook type PC to the HDMI 1 or HDMI 2 connector of your projector.



a: HDMI cable (not supplied) (Use a Premium High Speed HDMI Cable.) /

b: Audio cable (not supplied)

- Select the source name for its appropriate input connector after turning on the projector.

Input connector	INPUT button on the projector cabinet	Button on the remote control
HDMI 1	 HDMI1	HDMI1
HDMI 2	 HDMI2	HDMI2

TIP:

- For users of audio video equipment with an HDMI connector:
Select "Enhanced" rather than "Normal" if HDMI output is switchable between "Enhanced" and "Normal". This will provide improved image contrast and more detailed dark areas.
For more information on settings, refer to the instruction manual of the audio video equipment to be connected.
- When connecting the HDMI 1 or HDMI 2 connector of the projector to the Blu-ray player, the projector's video level can be made settings in accordance with the Blu-ray player's video level. In the menu select [ADJUST] → [VIDEO] → [VIDEO LEVEL] and make necessary settings.

7-3. Connecting to a HDBaseT transmission device (sold commercially)

Use a LAN cable sold commercially to connect the HDBaseT IN port of the projector to a HDBaseT transmission device sold commercially.

The HDBaseT IN port of the projector supports HDMI signals (HDCP) from transmission devices, control signals from external devices (serial, LAN) and remote control signals (IR commands).

- Refer to the owner's manual accompanied with your HDBaseT transmission for connecting with your external devices.

Connection example

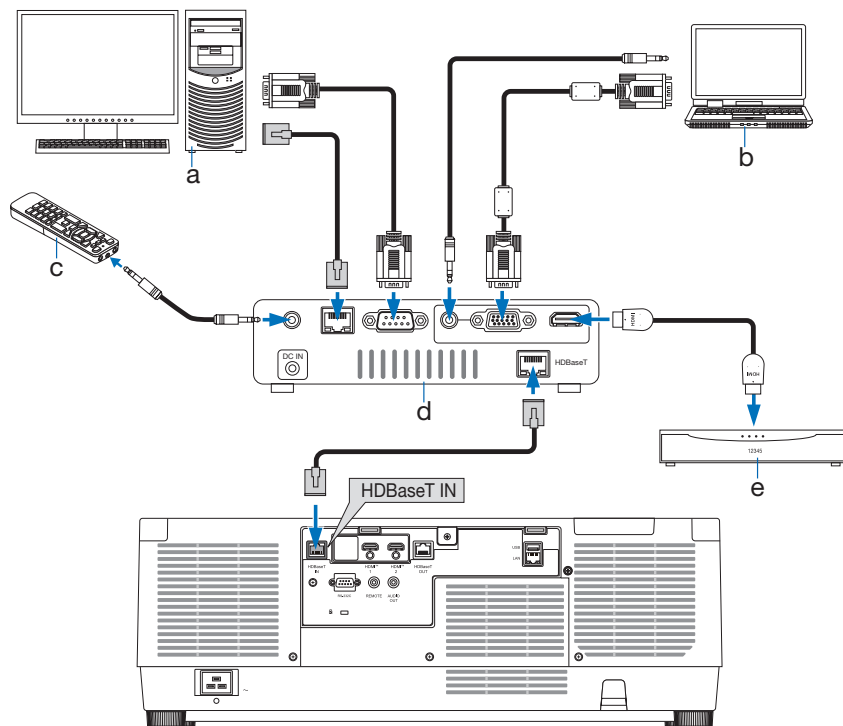

a: Computer (for control use) / b: Computer (for output use) / c: Remote control /
d: Example of a transmission device / e: HDMI output video device

NOTE:

- Please use a shielded twisted pair (STP) cable of Category 5e or higher for the LAN cable (sold commercially).
- The maximum transmission distance over the LAN cable is 100 m. (the maximum distance is 70 m for a 4K signal)
- Please do not use other transmission equipment between the projector and transmission equipment. The picture quality may be degraded as a result.
- This projector is not guaranteed to work with all HDBaseT transmission devices sold commercially.

7-4. Connecting to a Wired LAN

The projector comes standard with a LAN port which provides a LAN connection using a LAN cable. To use a LAN connection, you are required to set the LAN on the projector menu. Select [SETUP] → [NETWORK SETTINGS] → [WIRED LAN]. (→ page 135).

Example of LAN connection

Example of wired LAN connection

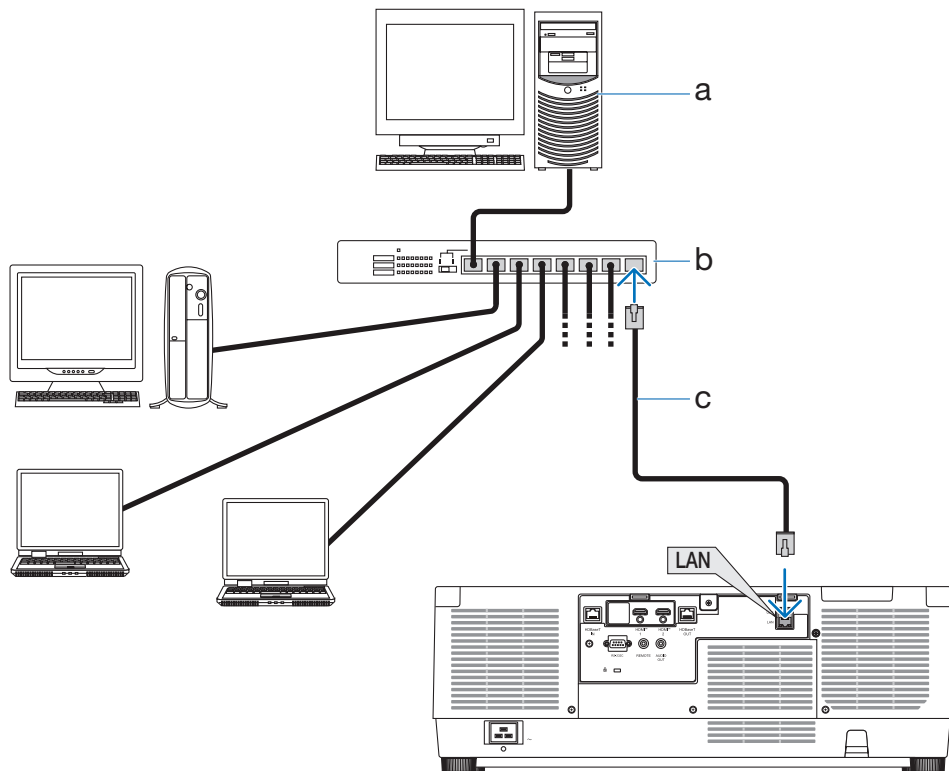

a: Server / b: Hub / c: LAN cable (not supplied) (Use a shielded twisted pair (STP) cable of Category 5e or higher for the LAN cable.)

7-5. Connecting several projectors

Example of a daisy change connection

It enables to project HDMI, HDBaseT image on several projectors connecting the HDBaseT IN port and the HDBaseT OUT port by LAN cable. You can connect up to four devices of the same model.

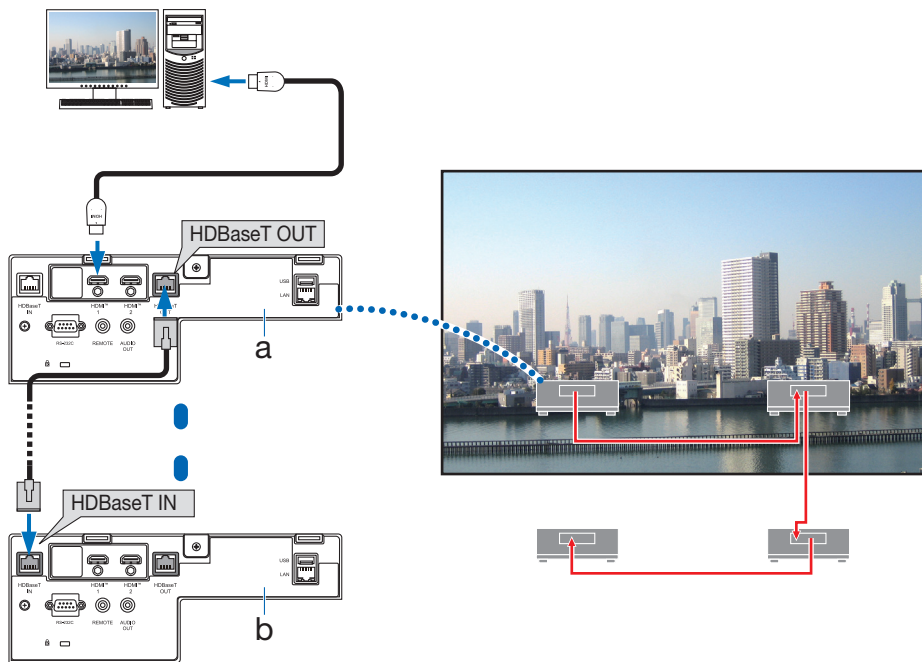

a: Master projector / b: Other projector

NOTE:

- When outputting HDMI signals, turn on the power of the video device on the output side and keep it connected before inputting video signals into this device. The HDBaseT OUT port of the projector is equipped with repeater function. When a device is connected to the HDBaseT OUT port, the resolution of the output signal is limited by the resolution supported by the connected device.
- Connecting and disconnecting an LAN cable or selecting another input source on the second and subsequent projectors will disable the HDBaseT repeater function.
- This projector is not guaranteed to work correctly in the connection with an other device as a monitor.

Example of a wired LAN connection

Connect this unit's LAN port to the router using a LAN cable. For details about the LAN settings, see [WIRED LAN] (→ page 135).

The video signal is input to the different projectors using a distributor.

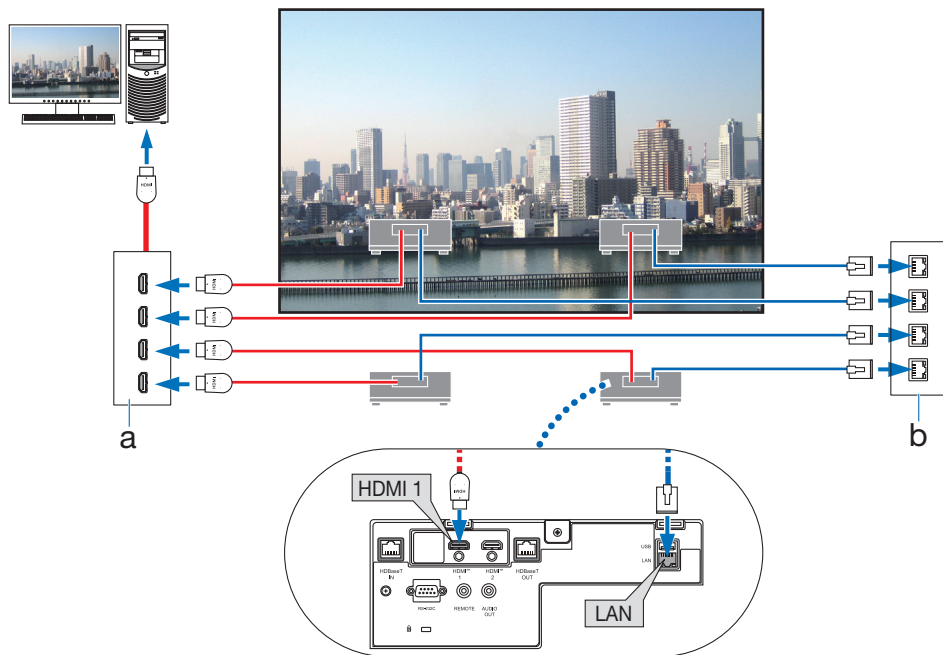

a: HDMI distributor / b: Router

NOTE:

- Set [HDBaseT OUT SELECT] to [OFF]. (→ page 139)

8. Maintenance

8-1. Cleaning the Lens

 **WARNING**

- Turn off the power, unplug the power plug from the socket and remove the lens for cleaning. If the unit turns on while cleaning the lens, the strong light from the lens could damage your eyes. It could also burn your fingers.
- Please do not use a spray containing flammable gas to remove dust attached to the lens. Doing so may result in fires.

Use a commercially available plastic lens cleaner.
Never use alcohol. It may cause damage to the lens surface.

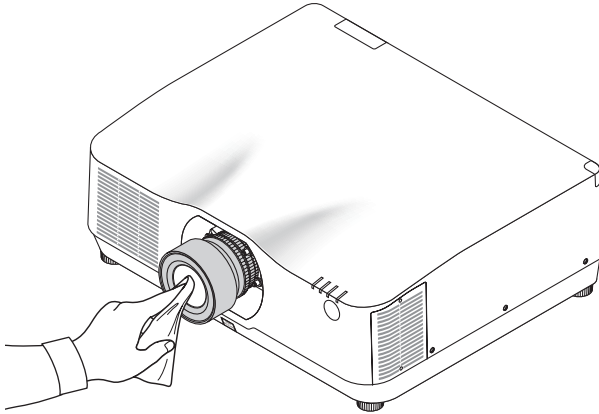

8-2. Cleaning the Cabinet

WARNING

- Turn off the projector, and unplug the projector before cleaning.
 - Please do not use a spray containing flammable gas to remove dust attached to the cabinet. Doing so may result in fires.
-
- Use a dry soft cloth to wipe dust off the cabinet.
If heavily soiled, use a mild detergent.
 - Never use strong detergents or solvents such as alcohol or thinner.
 - When cleaning the ventilation slits using a vacuum cleaner, do not force the brush of the vacuum cleaner into the slits of the cabinet.

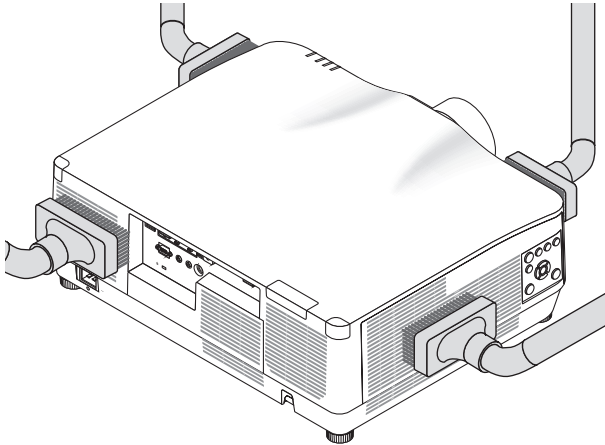

Vacuum the dust off the ventilation slits.

- Clogged ventilation slits may cause a rise in the internal temperature of the projector, resulting in malfunction.
- Do not scratch or hit the cabinet with your fingers or any hard objects
- Contact your dealer for cleaning the inside of the projector.

NOTE:

- Do not apply volatile agent such as insecticide on the cabinet, the lens, or the screen. Do not leave a rubber or vinyl product in prolonged contact with it. Otherwise the surface finish will be deteriorated or the coating may be stripped off.

9. Appendix

9-1. Throw distance and screen size

Five separate bayonet style lenses can be used on this projector. Refer to the information on this page and use a lens suited for the installation environment (screen size and throw distance).

Projection range for the different lenses

(Recommended distance from projector to screen)

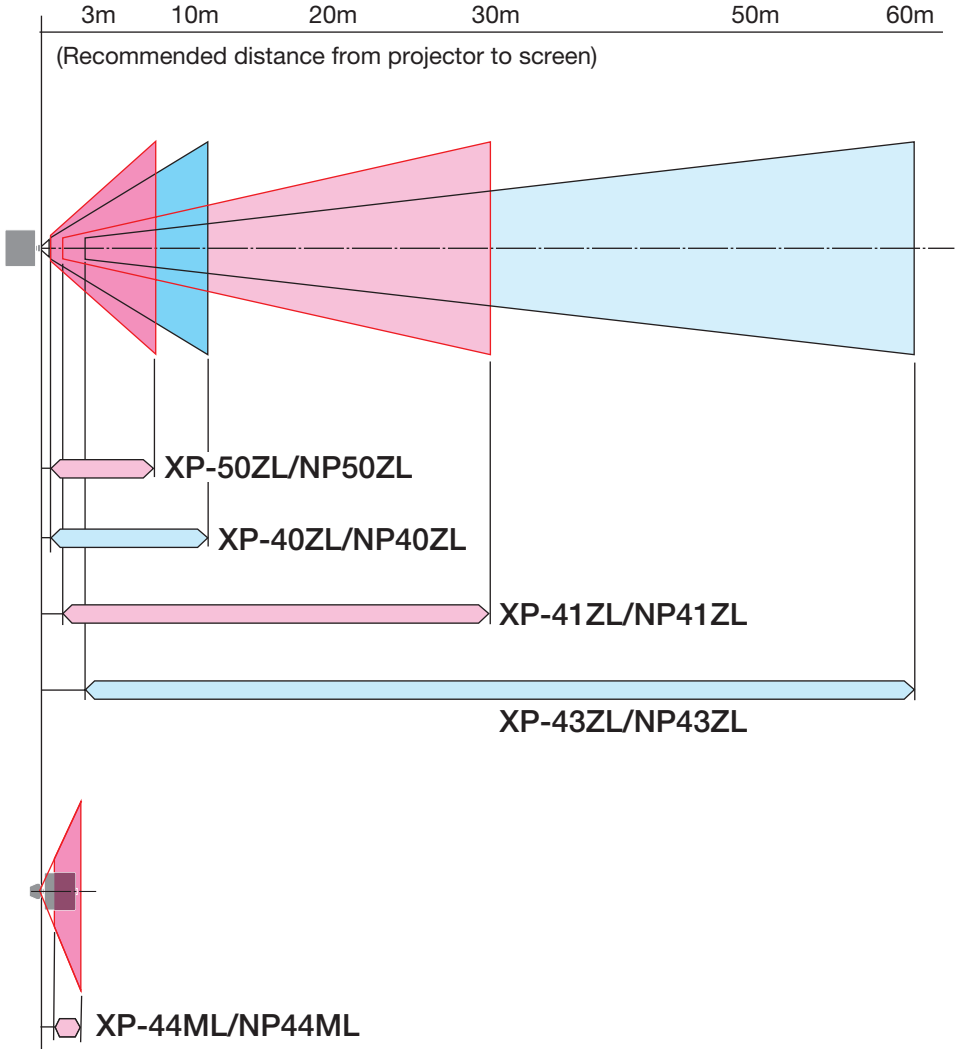

Lens types and throw distance (Aspect ratio 16:10)

(Unit: inch)

Screen size	Width × Height (inches)	Lens model name and throw distance				
		XP-40ZL/ NP40ZL	XP-41ZL/ NP41ZL	XP-43ZL/ NP43ZL	XP-50ZL/ NP50ZL	XP-44ML/ NP44ML
50	42 × 26	33 – 46	54 – 127	129 – 254	–	(*)
60	51 × 32	40 – 56	66 – 153	154 – 303	30 – 38	
80	68 × 42	53 – 75	88 – 204	204 – 403	41 – 51	
100	85 × 53	67 – 94	110 – 256	254 – 503	51 – 64	
120	102 × 64	81 – 113	133 – 307	303 – 602	62 – 77	
150	127 × 79	101 – 142	166 – 384	378 – 752	78 – 97	
200	170 × 106	135 – 190	223 – 513	502 – 1001	104 – 130	
240	204 × 127	163 – 229	267 – 616	601 – 1201	126 – 156	
300	254 × 159	204 – 286	335 – 770	750 – 1500	157 – 196	
400	339 × 212	272 – 382	447 – 1028	999 – 1998	211 – 262	
500	424 × 265	340 – 478	559 – 1285	1247 – 2497	264 – 328	

(Unit: m)

Screen size	Width × Height (cm)	Lens model name and throw distance				
		XP-40ZL/ NP40ZL	XP-41ZL/ NP41ZL	XP-43ZL/ NP43ZL	XP-50ZL/ NP50ZL	XP-44ML/ NP44ML
50	107.7 × 67.3	0.8 – 1.2	1.4 – 3.2	3.3 – 6.4	–	(*)
60	129.2 × 80.8	1.0 – 1.4	1.7 – 3.9	3.9 – 7.7	0.8 – 1.0	
80	172.3 × 107.7	1.4 – 1.9	2.2 – 5.2	5.2 – 10.2	1.0 – 1.3	
100	215.4 × 134.6	1.7 – 2.4	2.8 – 6.5	6.4 – 12.8	1.3 – 1.6	
120	258.5 × 161.5	2.0 – 2.9	3.4 – 7.8	7.7 – 15.3	1.6 – 2.0	
150	323.1 × 201.9	2.6 – 3.6	4.2 – 9.8	9.6 – 19.1	2.0 – 2.5	
200	430.8 × 269.2	3.4 – 4.8	5.7 – 13.0	12.7 – 25.4	2.6 – 3.3	
240	516.9 × 323.1	4.1 – 5.8	6.8 – 15.6	15.3 – 30.5	3.2 – 4.0	
300	646.2 × 403.9	5.2 – 7.3	8.5 – 19.6	19.1 – 38.1	4.0 – 5.0	
400	861.6 × 538.5	6.9 – 9.7	11.4 – 26.1	25.4 – 50.8	5.3 – 6.7	
500	1077.0 × 673.1	8.6 – 12.1	14.2 – 32.6	31.7 – 63.4	6.7 – 8.3	

(*) See page 170 for XP-44ML/NP44ML.

Lens types and throw distance (Aspect ratio 16:9)

(Unit: inch)

Screen size		Lens model name and throw distance				
	Width × Height (inches)	XP-40ZL/ NP40ZL	XP-41ZL/ NP41ZL	XP-43ZL/ NP43ZL	XP-50ZL/ NP50ZL	XP-44ML/ NP44ML
50	44 × 25	34 – 48	56 – 131	133 – 260	—	(*)
60	52 × 29	41 – 58	67 – 157	158 – 312	31 – 39	
80	70 × 39	55 – 77	90 – 210	209 – 414	42 – 52	
100	87 × 49	69 – 97	114 – 263	260 – 517	53 – 66	
120	105 × 59	83 – 117	137 – 316	312 – 619	64 – 79	
150	131 × 74	104 – 146	171 – 395	388 – 773	80 – 100	
200	174 × 98	139 – 196	229 – 527	516 – 1029	107 – 134	
240	209 × 118	167 – 235	275 – 633	618 – 1234	129 – 161	
300	261 × 147	209 – 294	344 – 792	771 – 1541	162 – 202	
400	349 × 196	280 – 393	459 – 1056	1026 – 2054	216 – 269	
500	436 × 245	350 – 491	575 – 1321	1282 – 2566	271 – 337	

(Unit: m)

Screen size		Lens model name and throw distance				
	Width × Height (cm)	XP-40ZL/ NP40ZL	XP-41ZL/ NP41ZL	XP-43ZL/ NP43ZL	XP-50ZL/ NP50ZL	XP-44ML/ NP44ML
50	110.7 × 62.3	0.9 – 1.2	1.4 – 3.3	3.4 – 6.6	—	(*)
60	132.8 × 74.7	1.0 – 1.5	1.7 – 4.0	4.0 – 7.9	0.8 – 1.0	
80	177.1 × 99.6	1.4 – 2.0	2.3 – 5.3	5.3 – 10.5	1.1 – 1.3	
100	221.4 × 124.5	1.7 – 2.5	2.9 – 6.7	6.6 – 13.1	1.3 – 1.7	
120	265.7 × 149.4	2.1 – 3.0	3.5 – 8.0	7.9 – 15.7	1.6 – 2.0	
150	332.1 × 186.8	2.6 – 3.7	4.3 – 10.0	9.9 – 19.6	2.0 – 2.5	
200	442.8 × 249.1	3.5 – 5.0	5.8 – 13.4	13.1 – 26.1	2.7 – 3.4	
240	531.3 × 298.9	4.2 – 6.0	7.0 – 16.1	15.7 – 31.3	3.3 – 4.1	
300	664.1 × 373.6	5.3 – 7.5	8.7 – 20.1	19.6 – 39.1	4.1 – 5.1	
400	885.5 × 498.1	7.1 – 10.0	11.7 – 26.8	26.1 – 52.2	5.5 – 6.8	
500	1106.9 × 622.6	8.9 – 12.5	14.6 – 33.5	32.6 – 65.2	6.9 – 8.6	

(*) See page 171 for XP-44ML/NP44ML.

Calculation of the throw distance from the screen size

L: Throw distance W: Screen width

Lens model name	Calculation formula (Zoom min to max)
XP-40ZL/NP40ZL	$L = W \times 0.8$ to $W \times 1.1$
XP-41ZL/NP41ZL	$L = W \times 1.3$ to $W \times 3.0$
XP-43ZL/NP43ZL	$L = W \times 3.0$ to $W \times 5.9$
XP-50ZL/NP50ZL	$L = W \times 0.6$ to $W \times 0.8$

Example: Throw distance when projecting on a 16:10 150" screen using the XP-41ZL lens:

According to the "Lens types and throw distance (Aspect ratio 16:10)" table (→ page 165), W (screen width) = 127"/323.1 cm.

The throw distance is 127"/323.1 cm \times 1.3 to 127"/323.1 cm \times 3.0 = 165"/420.0 cm to 381"/969.3 cm (because of the zoom lens).

* Your calculated figure has a few percent margin of error because the calculation formula is approximate.

Lens shifting range

This projector is equipped with a lens shift function for adjusting the position of the projected image by buttons. The lens can be shifted within the range shown below.

- See page 28 for lens shift operations and precautions.

Description of symbols: V indicates vertical (height of the projected image), H indicates horizontal (width of the projected image).

Desk/front projection

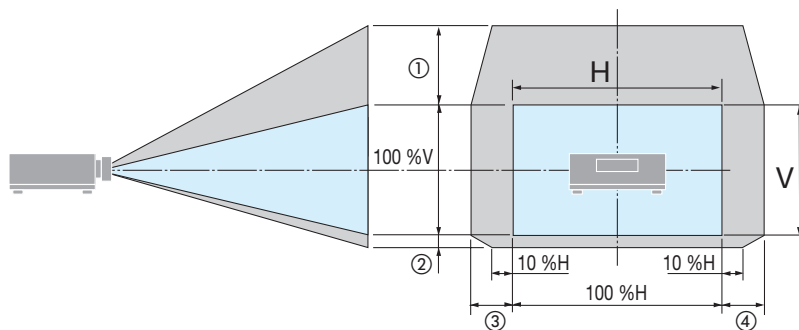

Ceiling/front projector

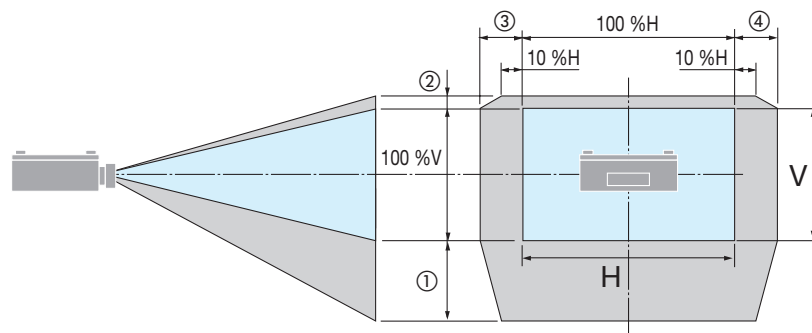

Number in the figure	Lens Unit			
	XP-40ZL/ NP40ZL	XP-41ZL/ NP41ZL	XP-43ZL/ NP43ZL	XP-50ZL/ NP50ZL
①	50%V			
②	10%V			
③	20%H			
④	20%H			

Example: When projecting on a 16:10 150" screen using the XP-40ZL lens:

According to the "Lens types and throw distance (Aspect ratio 16:10)" (→ page 165), H (screen width) = 323.1 cm and V (screen height) = 201.9 cm

Adjustment range in the vertical direction: The projected image can be moved upward $0.50 \times 201.9 \text{ cm} \approx 111 \text{ cm}$ and downward $0.1 \times 201.9 \text{ cm} \approx 20 \text{ cm}$ (when the lens is at the center position).

Adjustment range in the horizontal direction: The projected image can be moved to the left $0.20 \times 323.1 \text{ cm} \approx 65 \text{ cm}$, and this applies to the right direction which means approx. 65 cm.

* Your calculated figure has a few percent margin of error because the calculation formula is approximate.

NOTE:

- Fix the XP-50ZL/NP50ZL to the projector using the supplied support kit. Loosen the bolts of the support kit, you can adjust the lens shift.
 - Fix the XP-44ML/NP44ML to the projector using the separately sold support kit (XP-02LK/NP02LK). Lens shift is not available for the XP-44ML/NP44ML.
-

Throw distance when XP-44ML/NP44ML is attached

- If there is a wall below the screen bottom, allow 0.2 m/8" or longer of L1 distance to install the projector.

Aspect ratio 16:10

(Unit: inch)

Screen size	Width × Height (inches)	L1	L2	H1	H2
100	85 × 53	3	27	25	78
120	102 × 64	9	33	28	92
150	127 × 79	18	42	34	114
180	153 × 95	26	50	40	135
200	170 × 106	32	56	43	149
240	204 × 127	44	68	51	178
270	229 × 143	52	76	56	199
300	254 × 159	61	85	62	221
350	297 × 185	75	99	71	257
400	339 × 212	90	114	80	292

(Unit: m)

Screen size	Width × Height (cm)	L1	L2	H1	H2
100	215.4 × 134.6	0.08	0.70	0.63	1.98
120	258.5 × 161.5	0.23	0.84	0.72	2.34
150	323.1 × 201.9	0.45	1.06	0.86	2.88
180	387.7 × 242.3	0.67	1.28	1.01	3.43
200	430.8 × 269.2	0.81	1.43	1.10	3.79
240	516.9 × 323.1	1.11	1.72	1.29	4.52
270	581.6 × 363.5	1.33	1.94	1.43	5.07
300	646.2 × 403.9	1.54	2.16	1.57	5.61
350	753.9 × 471.2	1.91	2.52	1.81	6.65
400	861.6 × 538.5	2.28	2.89	2.04	7.43

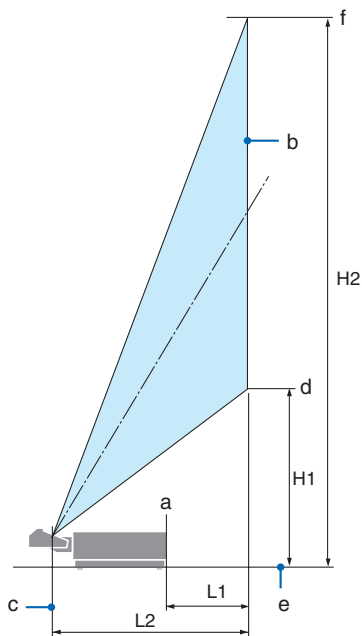

L1: The distance from the projector rear face (a) to the screen face (b)

L2: The distance from the center of the lens unit projection window (c) to the screen face (b)

H1: The height from the screen bottom (d) to the projector bottom face (e) (not including the tilt feet)

H2: The height from the screen top end (f) to the projector bottom face (e) (not including the tilt feet)

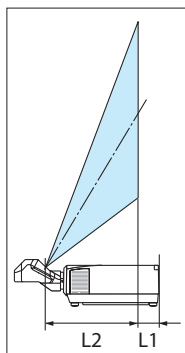

(when L1 is minus)

Aspect ratio 16:9

(Unit: inch)

Screen size	Width × Height	L1	L2	H1	H2
	(inches)				
80	70 × 39	-2	22	24	63
100	87 × 49	4	28	28	77
120	105 × 59	10	34	32	91
150	131 × 74	19	43	39	112
180	157 × 88	28	52	45	134
200	174 × 98	34	58	50	148
240	209 × 118	45	70	58	176
270	235 × 132	54	79	65	197
300	261 × 147	63	87	72	219
350	305 × 172	78	102	82	254
400	349 × 196	93	117	93	290

(Unit: m)

Screen size	Width × Height	L1	L2	H1	H2
	(cm)				
80	177.1 × 99.6	-0.05	0.57	0.60	1.60
100	221.4 × 124.5	0.10	0.72	0.71	1.96
120	265.7 × 149.4	0.25	0.87	0.82	2.32
150	332.1 × 186.8	0.48	1.09	0.99	2.86
180	398.5 × 224.1	0.70	1.32	1.15	3.40
200	442.8 × 249.1	0.85	1.47	1.26	3.76
240	531.3 × 298.9	1.16	1.77	1.49	4.48
270	597.7 × 336.2	1.38	1.99	1.65	5.02
300	664.1 × 373.6	1.61	2.22	1.82	5.55
350	774.8 × 435.8	1.98	2.59	2.09	6.45
400	885.5 × 498.1	2.36	2.97	2.37	7.35

Calculation of the throw distance from the screen size

L2: Distance between the center of the lens unit projection window and the screen face

W: Screen width

Lens model name	Calculation formula
XP-44ML/NP44ML	$L2 = W \times 0.32$

Example: Throw distance when projecting on a 16:10 150" screen:

According to the table (→ page 170), W (screen width) = 127"/323.1 cm.

The throw distance is 127"/323.1 cm × 0.32 = 41"/103.4 cm.

* Your calculated figure has a few percent margin of error because the calculation formula is approximate.

9-2. Compatible Input Signal List

HDMI

Signal	Resolution (dots)	Aspect Ratio	Refresh Rate (Hz)	Bit Depth	Signal Type
VGA	640 × 480	4 : 3	60	8	RGB
SVGA	800 × 600	4 : 3	60	8	RGB
XGA	1024 × 768	4 : 3	60	8	RGB
HD	1280 × 720	16 : 9	60	8	RGB
WXGA	1280 × 768	15 : 9	60	8	RGB
	1280 × 800	16 : 10	60	8	RGB
Quad-VGA	1280 × 960	4 : 3	60	8	RGB
SXGA	1280 × 1024	5 : 4	60	8	RGB
FWXGA	1360 × 768	16 : 9	60	8	RGB
	1366 × 768	16 : 9	60	8	RGB
SXGA+	1400 × 1050	4 : 3	60	8	RGB
WXGA+	1440 × 900	16 : 10	60	8	RGB
WXGA++	1600 × 900	16 : 9	60	8	RGB
WSXGA+	1680 × 1050	16 : 10	60	8	RGB
UXGA	1600 × 1200 *1	4 : 3	60	8	RGB
Full HD	1920 × 1080 *1	16 : 9	60	8	RGB
WUXGA	1920 × 1200 *1	16 : 10	60 Reduced Blanking	8	RGB
WQHD	2560 × 1440	16 : 9	60 Reduced Blanking	8	RGB
WQXGA	2560 × 1600	16 : 10	60 Reduced Blanking	8	RGB
UWFHD	2560 × 1080	21 : 9	24/25/30/50/60	8/10/12 *2	RGB/ YCbCr4:4:4/ YCbCr4:2:2
UHD	3840 × 2160	16 : 9	24/25/30	8/10/12 *2	RGB/ YCbCr4:4:4/ YCbCr4:2:2
			50/60	8	RGB/ YCbCr4:4:4
				8/10/12 *2	YCbCr4:2:2/ YCbCr4:2:0
4K	4096 × 2160	17 : 9	24/25/30	8/10/12 *2	RGB/ YCbCr4:4:4/ YCbCr4:2:2
			50/60	8	RGB/ YCbCr4:4:4
				8/10/12 *2	YCbCr4:2:2/ YCbCr4:2:0
HDTV(1080p)	1920 × 1080 *1	16 : 9	24/25/30/50/60	8/10/12 *2	RGB/ YCbCr4:4:4/ YCbCr4:2:2
HDTV(1080i)	1920 × 1080 *1	16 : 9	50/60		
HDTV (720p)	1280 × 720	16 : 9	50/60		
SDTV (480p)	720/1440 × 480	4:3 / 16:9	60		
SDTV (576p)	720/1440 × 576	4:3 / 16:9	50		
SDTV(480i)	1440 × 480	4:3 / 16:9	60		
SDTV(576i)	1440 × 576	4:3 / 16:9	50		

HDBaseT

Signal	Resolution (dots)	Aspect Ratio	Refresh Rate (Hz)	Bit Depth	Signal Type
VGA	640 × 480	4 : 3	60	8	RGB
SVGA	800 × 600	4 : 3	60	8	RGB
XGA	1024 × 768	4 : 3	60	8	RGB
HD	1280 × 720	16 : 9	60	8	RGB
WXGA	1280 × 768	15 : 9	60	8	RGB
	1280 × 800	16 : 10	60	8	RGB
Quad-VGA	1280 × 960	4 : 3	60	8	RGB
SXGA	1280 × 1024	5 : 4	60	8	RGB
FWXGA	1360 × 768	16 : 9	60	8	RGB
	1366 × 768	16 : 9	60	8	RGB
SXGA+	1400 × 1050	4 : 3	60	8	RGB
WXGA+	1440 × 900	16 : 10	60	8	RGB
WXGA++	1600 × 900	16 : 9	60	8	RGB
WSXGA+	1680 × 1050	16 : 10	60	8	RGB
UXGA	1600 × 1200 *1	4 : 3	60	8	RGB
Full HD	1920 × 1080 *1	16 : 9	60	8	RGB
WUXGA	1920 × 1200 *1	16 : 10	60 Reduced Blanking	8	RGB
WQHD	2560 × 1440	16 : 9	60 Reduced Blanking	8	RGB
WQXGA	2560 × 1600	16 : 10	60 Reduced Blanking	8	RGB
UWFHD	2560 × 1080	21 : 9	24/25/30/50/60	8/10/12 *2	RGB/ YCbCr4:4:4/ YCbCr4:2:2
UHD	3840 × 2160	16 : 9	24/25/30	8	RGB/YCb- Cr4:4:4
				8/10/12 *2	YCbCr4:2:2
4K	4096 × 2160	17 : 9	24/25/30	8	RGB/YCb- Cr4:4:4
				8/10/12 *2	YCbCr4:2:2
HDTV(1080p)	1920 × 1080 *1	16 : 9	24/25/30/50/60	8/10/12 *2	RGB/ YCbCr4:4:4/ YCbCr4:2:2
HDTV(1080i)	1920 × 1080 *1	16 : 9	50/60		
HDTV (720p)	1280 × 720	16 : 9	50/60		
SDTV (480p)	720/1440 × 480	4:3 / 16:9	60		
SDTV (576p)	720/1440 × 576	4:3 / 16:9	50		
SDTV(480i)	1440 × 480	4:3 / 16:9	60		
SDTV(576i)	1440 × 576	4:3 / 16:9	50		

*1 Native resolution

If a signal except "Native Resolution" is input, the scaling may cause uneven thickness of characters and ruled lines, and blurred colors.

*2 When the signal format is YCbCr4:2:2, [BIT DEPTH] information is not displayed in [INFO.] → [SOURCE(2)] screen of the on-screen menu.

9-3. Specifications

Model name		A104U-W/A104U-B	A824U-W/A824U-B
Method		Three primary color liquid crystal shutter projection method	
Specifications of main parts			
Liquid crystal panel	Size	0.76" × 3 (aspect ratio: 16:10)	
	Pixels ^{(*)1}	2,304,000 (1920 dots × 1200 lines)	
Projection lenses	Refer to the specifications of option lens (→ 176 page)		
	Zoom	Motorized	
	Focus	Motorized	
	Lens shifting	Motorized	
Light source		Laser diode with Phosphor	
Optical device		Optical isolation by dichroic mirror, combining by dichroic prism	
Light output ^{(*)2}		10000 lm ^{(*)3} 10500 lm (Center)	8200 lm ^{(*)3} 8600 lm (Center)
Screen size (throw distance)		50"–500" (Throw distance depends on the lens)	
Color reproducibility		10-bit color processing (approx. 1.07 billion colors)	
Scanning frequency	Horizontal	15 kHz, 24 to 153 kHz	
	Vertical	24, 25, 30, 48 Hz, 50 to 85 Hz, 100, 120 Hz	
Input/output connectors			
HDMI IN 1/2	Video input	Type A × 2 Deep Color, LipSync, HDCP ^{(*)4} , 4K	
	Audio input	Sampling frequency: 32/44.1/48 kHz Sampling bits: 16/20/24 bit	
HDBaseT IN	Video input	RJ-45 x1, Deep Color, LipSync, HDCP ^{(*)4} , 4K	
	Audio input	Sampling frequency: 32/44.1/48 kHz Sampling bits: 16/20/24 bit	
	Control	100BASE-TX, Art-Net, PLink class2	
HDBaseT OUT	Video output	RJ-45 x1, Deep Color, LipSync, HDCP ^{(*)4} , 4K	
	Audio output	Sampling frequency: 32/44.1/48 kHz Sampling bits: 16/20/24 bit	
	Control	100BASE-TX, Art-Net, PLink class2	
AUDIO OUT		Stereo mini jack × 1 (Common to all signals)	
USB		USB type A × 1, 5.0V/1.4 A power supply	
Control Terminals	LAN	RJ-45 × 1, 10BASE-T/100BASE-TX, Art-Net, PLink class2	
	RS-232C	D-Sub 9-pin × 1	
	REMOTE	Stereo mini jack × 1	
Built-in Speaker		Not applicable	
Usage environment ^{(*)5}		Operating temperature: 32 to 104°F (0 to 40°C) Operating humidity: 20 to 80% (with no condensation) Storage temperature: 14 to 122°F (–10 to 50°C) Storage humidity: 20 to 80% (with no condensation) Operating altitude: 0 to 3650 m/12000 feet	
Power supply		100-240 V AC, 50/60 Hz	
Power consumption		810 W (100-130 V AC) 785 W (200-240 V AC)	630 W (100-130 V AC) 615 W (200-240 V AC)

Model name		A104U-W/A104U-B	A824U-W/A824U-B
Power consumption (Standby state)	Network enabled	0.7 W (100-130 V AC)/0.8 W (200-240 V AC)	
	Network disabled	0.20 W (100-130 V AC)/0.26 W (200-240 V AC)	
Rated input current		10.5 A (100-130 V AC) - 4.6 A (200-240 V AC)	8.6 A (100-130 V AC) - 3.8 A (200-240 V AC)
Power cord specification		15 A or higher	
External dimensions		23.6" (width) × 8.2" (height) × 19.3" (depth)/ 599 (width) × 208 (height) × 490 (depth) mm (not including protruding parts)	
		23.6" (width) × 8.5" (height) × 19.3" (depth)/ 599 (width) × 216 (height) × 490 (depth) mm (including protruding parts)	
Weight		53.8 lbs/24.4 kg (not including lens)	53.1 lbs/24.1 kg (not including lens)

- *1 Effective pixels are more than 99.99%.
- *2 This is the brightness when lens unit XP-41ZL (sold separately) is attached and [REF. LIGHT MODE] is set to [NORMAL], [REF. LIGHT ADJUST] is set to [100], and [PRESET] is set to [HIGH-BRIGHT]. Using [LIGHT ADJUST] will reduce brightness. If any other mode is selected as the [PRESET] mode, the light output value may drop slightly.
- *3 Compliance with ISO21118-2020
- *4 If you are unable to view material via the HDMI input, this does not necessarily mean the projector is not functioning properly. With the implementation of HDCP, there may be cases in which certain content is protected with HDCP and might not be displayed due to the decision/intention of the HDCP community (Digital Content Protection, LLC).
Video: HDR, Deep Color, 8/10/12-bit, Lip Sync.
Audio: LPCM; up to 2 ch, sample rate 32/44.1/48 KHz, sample bit; 16/20/24-bit
HDMI: Supports HDCP 2.2/1.4
HDBaseT: Supports HDCP 2.2/1.4
- *5 The projector's protection functions will activate depending on the temperature of the operating environment. (→ page 42)
- For additional information visit:
US: <https://business.sharppusa.com/>
Europe: <https://www.sharpnecdisplays.eu>
Global: <https://www.sharp-nec-displays.com/global/>
For information on our optional accessories, visit our website or see our brochure.
The specifications are subject to change without notice.

Option lens (sold separately)

Lens model name		Specifications
XP lenses	NP lenses	
XP-40ZL	NP40ZL	Throw ratio 0.79–1.11 : 1, F2.0–2.5, f=13.3–18.6 mm
XP-41ZL	NP41ZL	Throw ratio 1.30–3.02 : 1, F1.7–2.0, f=21.8–49.8 mm
XP-43ZL	NP43ZL	Throw ratio 2.99–5.93 : 1, F2.2–2.6, f=49.7–99.8 mm
XP-50ZL	NP50ZL	Throw ratio 0.60–0.75 : 1, F1.9–2.1, f=10.2–12.8 mm
XP-44ML	NP44ML	Throw ratio 0.32 : 1, F2.0, f=6.27 mm

Lens model name	Function	Motorized lens shift	Motorized zoom	Focus				LENS CALI- BRATION	Home position	REF. LENS MEMORY
				Motorized		Manual				LENS MEMORY
				CENTER	PERIPHERY	CENTER	PERIPHERY			
XP-40ZL/NP40ZL	Yes	Yes	Yes	Yes	No	No	Yes ^{(*)2}	Yes	Yes ^{(*)2}	
XP-41ZL/NP41ZL	Yes	Yes	Yes	Yes	No	No	Yes ^{(*)2}	Yes	Yes ^{(*)2}	
XP-43ZL/NP43ZL	Yes	Yes	Yes	No	No	No	Yes ^{(*)2}	Yes	Yes ^{(*)2}	
XP-50ZL/NP50ZL	Yes	Yes	Yes	No	No	Yes	Yes ^{(*)1}	Yes	No	
XP-44ML/NP44ML	No	No	Yes	Yes ^{(*)3}	No	No	Yes ^{(*)1}	Yes	No	

*1 Lens shift only

*2 Except [PERIPHERY] focus

*3 Adjust on the [LENS ZOOM] control screen

NOTE:

- The above throw ratio is for projecting on 100" screen.
- Even if an NP model lens unit is installed, the XP model will be displayed in the on-screen menu [INFO.] - [OTHERS] - [LENS ID].
- Fix the XP-50ZL/NP50ZL to the projector using the supplied support kit. Loosen the bolts of the support kit, you can adjust the lens shift.
- Fix the XP-44ML/NP44ML to the projector using the separately sold support kit (XP-02LK/NP02LK).

9-4. Cabinet Dimensions

Unit: mm (inch)

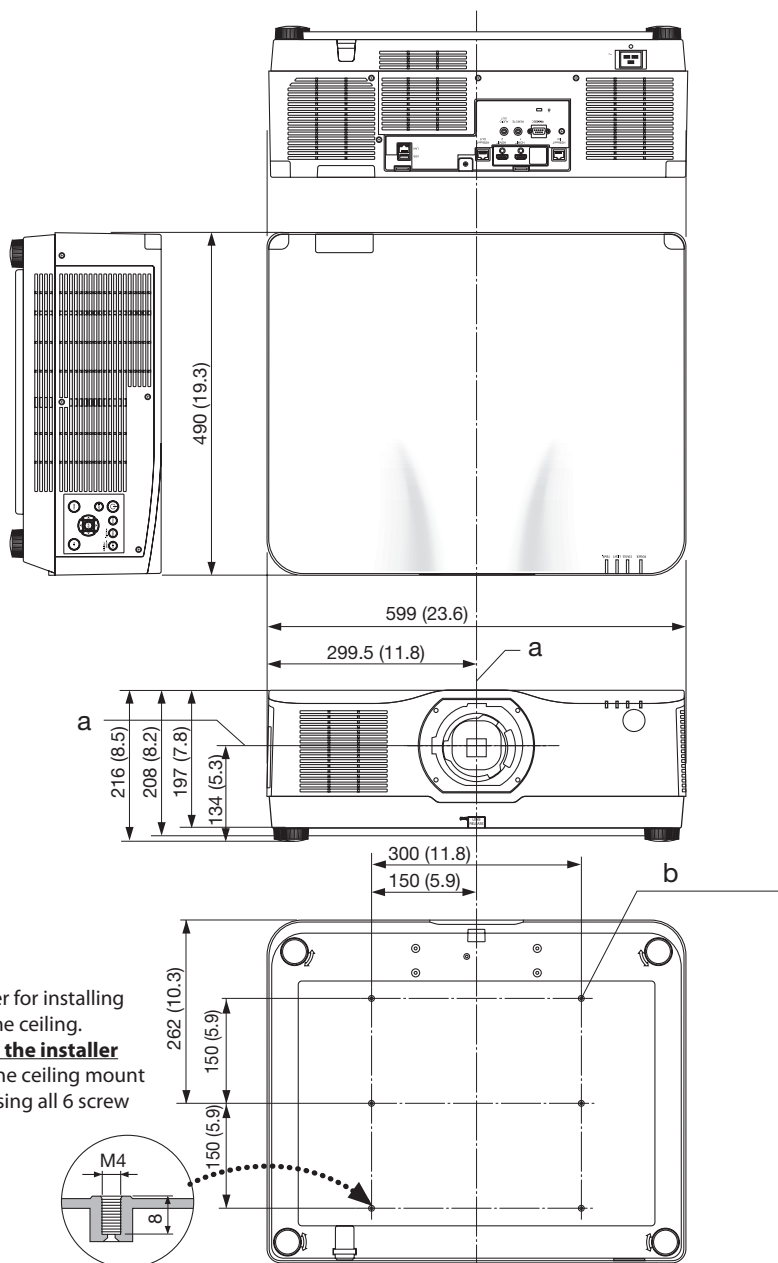

* Consult your dealer for installing the projector on the ceiling.
To the dealer and the installer
 Be sure to fasten the ceiling mount fittings securely, using all 6 screw holes.

a: Lens center / b: 6 M4mm screw holes of 8mm depth (for Ceiling Mount)*

9-5. Pin assignments and signal names of main connectors

HDMI 1/HDMI 2 Connector (Type A)

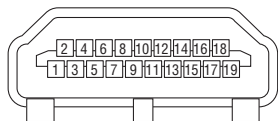

Pin No.	Signal
1	TMDS Data 2+
2	TMDS Data 2 Shield
3	TMDS Data 2–
4	TMDS Data 1+
5	TMDS Data 1 Shield
6	TMDS Data 1–
7	TMDS Data 0+
8	TMDS Data 0 Shield
9	TMDS Data 0–
10	TMDS Clock +
11	TMDS Clock Shield
12	TMDS Clock–
13	CEC
14	Disconnection
15	SCL
16	SDA
17	DDC/CEC grounding
18	+5 V power supply
19	Hot plug detection

HDBaseT Port (RJ-45)

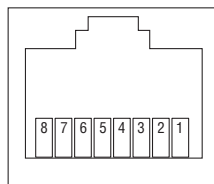

Pin No.	Signal
1	TxD+/HDBT0+
2	TxD–/HDBT0–
3	RxD+/HDBT1+
4	Disconnection/HDBT2+
5	Disconnection/HDBT2–
6	RxD–/HDBT1–
7	Disconnection/HDBT3+
8	Disconnection/HDBT3–

USB Port (Type A)

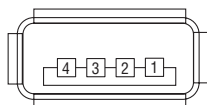

Pin No.	Signal
1	V _{BUS}
2	D–
3	D+
4	Grounding

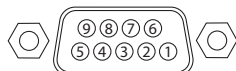
PC CONTROL Port (D-Sub 9 Pin)

Pin No.	Signal
1	Unused
2	RxD reception data
3	TxD transmission data
4	Unused
5	Grounding
6	Unused
7	RTS transmission request
8	CTS transmission allowed
9	Unused

9-6. Portrait projection (vertical orientation)

Portrait screens from a computer can be projected by installing the projector in a vertical orientation.

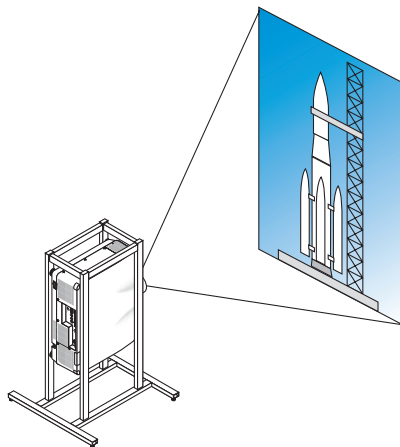

Precautions during installation

- Please do not install the projector in a vertical orientation on top of the floor or table on its own. If not, the projector may fall over, resulting in injury, damage or malfunction. Also, the exhaust vent may be obstructed, resulting in the projector getting warm and the possibility of fire and malfunction occurring.
- A stand for supporting the projector needs to be made for portrait projection and for installing the projector in universal angle. In this case, the stand must be designed such that the center of gravity of the projector is located well within the legs of the stand. If not, the projector may fall over and result in injury, damage and malfunction.

Design and manufacturing conditions for the stand

Please engage an installation service provider for the design and manufacture of the customized stand to be used for portrait projection. Please ensure that the following are complied with when designing the stand.

1. Secure sufficient space between the projector and the floor. (→ [next page](#))
2. Use the four screw holes at the back of the projector to secure it to the stand.
Screw hole center dimension: width 300 mm, lengthwise pitch 150 mm
Screw hole dimension on the projector: M4 with a maximum depth of 8 mm.
 - * Please design the stand such that the rear legs at the back of the projector do not contact the stand. The front legs can be turned and removed.
3. Horizontal adjustment mechanism (for example, bolts and nuts in four locations)
4. Please design the stand such that it does not topple over easily.

Reference drawings

* The drawing showing the dimensional requirements is not an actual stand design drawing.

(Unit: mm)

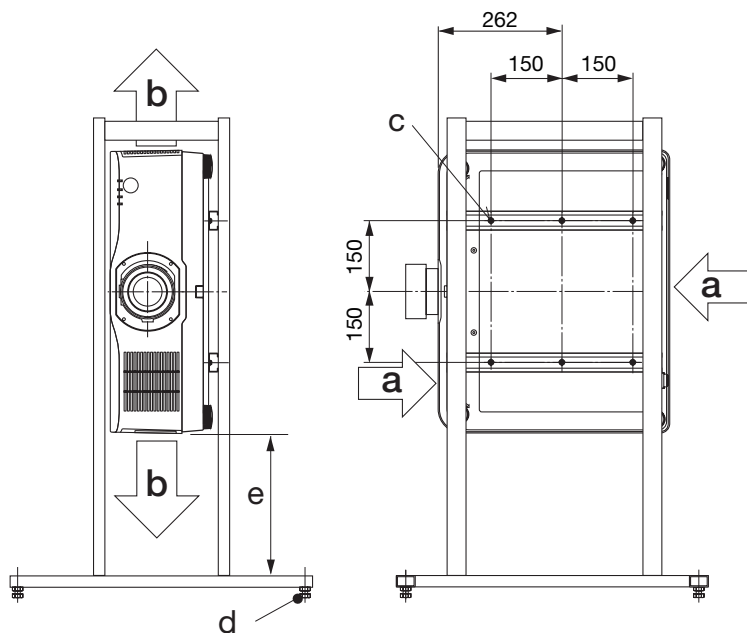

a: Intake air / b: Exhaust / c: Screw 8 - M4 / d: Horizontal adjuster / e: 300 or more *

* The example shows the side where the controls and exhaust vent is located facing downwards. To make the side where the controls and exhaust vent is located face upwards, leave a space of 200 mm or more.

9-7. Troubleshooting





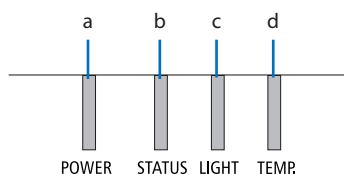



























This section helps you resolve problems you may encounter while setting up or using the projector.



















Feature of each indicator



- a. POWER indicator
- b. STATUS indicator
- c. LIGHT indicator
- d. TEMP. indicator

Indicator Message (Status message)

POWER	STATUS	LIGHT	TEMP.	Projector status
 Off	 Off	 Off	 Off	Power is off
 Orange (Blink ^{*1})	 Off	 Off	 Off	In the state of Standby ([POWER-SAVING] is [ON] and the network is ready).
 Orange (Blink ^{*2})	 Off	 Off	 Off	In the state of Standby ([POWER-SAVING] is [ON] and the network is unavailable).
 Orange (Light)	 Off	 Off	 Off	In the state of Standby ([POWER-SAVING] is [ON] and the network is available)
 Orange (Blink ^{*3})	 Off	 Off	 Off	[ON] time as the [PROGRAM TIMER] is activated. (In the state of Standby)
 Green (Light)	 Off	 Off	 Off	In the state of Sleep
 Green (Blink ^{*3})	 Off	 Off	 Off	[ON] time as the [PROGRAM TIMER] is activated. (In the state of Sleep)
 Blue (Light)	 Off	 Green (Light)	 Off	Powered state ([REF. LIGHT MODE] is [NORMAL])

POWER	STATUS	LIGHT	TEMP.	Projector status
 Blue (Light)	 Off	 Green (Blink* ³)	 Off	Powered state ([REF. LIGHT MODE] is [SILENT] or [LONG LIFE])
Status varies	 Orange (Blink* ⁴)	Status varies	 Off	[LENS CALIBRATION] implement request.
 Blue (Light)	 Green (Blink* ⁴)	Status varies	 Off	Performing the lens calibration
 Blue (Light)	Status varies	 Off	 Off	Shutter function is activating
 Blue (Blink* ³)	 Off	Status varies	 Off	[OFF TIMER] is activated, [OFF] time as the [PROGRAM TIMER] is activated (Powered state)
 Blue (Blink* ⁵)	 Off	 Off	 Off	Preparing for powering [ON]

*1 Repetition to light on for 1.5 seconds / off for 1.5 seconds





















*2 Repetition to light on for 1.5 seconds / off for 7.5 seconds

*3 Repetition to light on for 2.5 seconds / off for 0.5 seconds

*4 Repetition to light on for 0.5 seconds / off for 0.5 seconds / on for 0.5 seconds / off for 2.5 seconds

*5 Repetition to light on for 0.5 seconds / off for 0.5 seconds

Indicator Message (Error message)

POWER	STATUS	LIGHT	TEMP.	Projector status	Procedure
 Blue (Light)	 Orange (Light)	Status varies	 Off	A button has been pressed while the [CONTROL PANEL LOCK] is activated.	The [CONTROL PANEL LOCK] is activated. The setting must be canceled to operate the projector. (→ page 127)
				ID numbers for the projector and the remote control do not match.	Check the [CONTROL ID] (→ page 128)
 Blue (Light)	 Off	 Orange (Light)	 Orange (Light)	Temperature problem	Ambient temperature is high. The projector's protection functions will activate depending on the temperature of the operating environment. Lower the room temperature.
 Red (Blink* ⁵)	 Off	 Off	 Off	Temperature problem	Ambient temperature is out of the operation temperature. Check if any obstruction stays near the exhaust vent.
 Red (Blink* ⁵)	 Red (Light)	 Red (Light)	 Off	Lens mounting error	Lens is not mounted properly. Mount it.
 Blue (Light)	Status varies	 Orange (Blink* ³) or (Blink* ⁵)  Red (Light)	Status varies	Error requiring service support	Although the projector can still be used, we recommend that you contact your dealer or service personnel and request an inspection.
 Red (Light)	Status varies	Status varies	 Off	Error requiring service support	Contact your dealer or service personnel. Make sure to check and inform indicator status for asking to repair.

*3 Repetition to light on for 2.5 seconds / off for 0.5 seconds

*5 Repetition to light on for 0.5 seconds / off for 0.5 seconds

When the thermal protector is activated:

When inside temperature of the projector becomes too high or low, the POWER indicator start to red blink in a short cycle. After this happened, the thermal protector will activate and the projector may be turned off.

In this case, please take the below measures:

- Pull out the power plug from the wall inlet.
- Place the projector in cool place if it has been placed in high ambient temperature.
- Clean the exhaust vent if dust has accumulated on.
- Leave the projector for about one hour until inside temperature gets lower.

Common Problems & Solutions

(→ “Indicator Message” on page 182.)

Problem	Check These Items
Does not turn on or shut down	<ul style="list-style-type: none"> • Check that the power cord is plugged in and that the power button on the projector cabinet or the remote control is on. (→ pages 19, 22) • Check to see if the projector has temperature error. If projector inside temperature is too hot or cool, it disabled to turn on the projector as the protection. Wait for a moment and try turn on the projector again. • In case it's hard to think the trouble is not caused on the above mentioned conditions, unplug the power cord from the outlet. Then wait 5 minutes before plugging it in again. (→ page 37)
Will turn off	<ul style="list-style-type: none"> • Ensure that the [OFF TIMER], [AUTO POWER OFF] or [PROGRAM TIMER] is off. (→ page 142, 123)
No picture	<ul style="list-style-type: none"> • Check if the appropriate input is selected. (→ page 25) If there is still no picture, press the INPUT button or one of the input buttons again. • Ensure your cables are connected properly. • Use menus to adjust the brightness and contrast. (→ page 97) • Is the [POWER ON SHUTTER] in the on-screen menu set to [CLOSE]? • Check that the SHUTTER CLOSE button is not pressed. • Reset the settings or adjustments to factory preset levels using the [RESET] in the Menu. (→ page 143) • Enter your registered keyword if the [START-UP LOCK] function is enabled. (→ page 49) • If the HDMI input signal cannot be displayed, try the following. Reinstall your driver for the graphics card built in your computer, or use the updated driver. For reinstalling or updating your driver, refer to the user guide accompanied with your computer or graphics card, or contact the support center for your computer manufacturer. Install the updated driver or OS on your own responsibility. We are not liable for any trouble and failure caused by this installation. • The signal may not be supported depending on the HDBaseT transmission device. In addition, RS-232C interface may not be supported. • If the projector is kept in sleep mode or other similar state, the temperature of the internal components could rise even when the projector is being used within its normal operating temperate. If the power is ON when that occurs, the cooling fan will turn on and it will take a little bit of time before the image is projected. Please wait for a while.
Picture suddenly becomes dark	<ul style="list-style-type: none"> • A hot room may trigger the projector's protection functions, which can result in a temporary reduction in luminance (brightness). Reduce the temperature in the room.
Color tone or hue is unusual	<ul style="list-style-type: none"> • Check if an appropriate color is selected in [WALL COLOR]. If so, select an appropriate option. (→ page 119) • Adjust [HUE] in [PICTURE]. (→ page 97)
Image isn't square to the screen	<ul style="list-style-type: none"> • Reposition the projector to improve its angle to the screen. (→ page 27) • Perform [GEOMETRIC CORRECTION] when the trapezoid is distorted. (→ page 44)

Problem	Check These Items
Picture is blurred	<ul style="list-style-type: none"> • Adjust the focus. (→ page 30) • Reposition the projector to improve its angle to the screen. (→ page 27) • Ensure that the distance between the projector and screen is within the adjustment range of the lens. (→ page 164) • Has the lens been shifted by an amount exceeding the guaranteed range? (→ page 168) • Condensation may form on the lens if the projector is cold, brought into a warm place and is then turned on. Should this happen, let the projector stand until there is no condensation on the lens.
Image is scrolling vertically, horizontally or both	<ul style="list-style-type: none"> • Check the computer's resolution and frequency. Make sure that the resolution you are trying to display is supported by the projector. (→ page 172) • Adjust the computer image manually with the Horizontal/Vertical in the [IMAGE OPTIONS]. (→ page 98)
Remote control does not work	<ul style="list-style-type: none"> • Aim the remote control's infrared transmitter towards the projector's remote control receiver. (→ page 16) • Install new batteries. (→ page 15) • Make sure there are no obstacles between you and the projector. • Stand within 20 m/787 inch of the projector. (→ page 16) • If a [CONTROL ID] has been set, check whether the ID number for the remote control matches the ID number for the projector. (→ page 128)
On-screen menu is not displayed	<ul style="list-style-type: none"> • Check whether On-screen mute is active. (→ page 38) <p>On-screen mute can be turned off using one of the following ways:</p> <ul style="list-style-type: none"> - Press the OSD OPEN button while holding down the CTL button on the remote control. - Holding down the MENU button on the projector cabinet for at least 10 seconds.
Indicator is lit or blinking	<ul style="list-style-type: none"> • See the Indicator Message. (→ page 182)

For more information contact your dealer.

9-8. PC Control Codes and Cable Connection

PC Control Codes

Command Format - A

Function	Code Data							
POWER ON	02H	00H	00H	00H	00H	02H		
POWER OFF	02H	01H	00H	00H	00H	03H		
INPUT SELECT HDMI1	02H	03H	00H	00H	02H	01H	A1H	A9H
INPUT SELECT HDMI2	02H	03H	00H	00H	02H	01H	A2H	AAH
INPUT SELECT HDBaseT	02H	03H	00H	00H	02H	01H	BFH	C7H
BLANK ON	02H	10H	00H	00H	00H	12H		
BLANK OFF	02H	11H	00H	00H	00H	13H		
MUTE ON	02H	12H	00H	00H	00H	14H		
MUTE OFF	02H	13H	00H	00H	00H	15H		

Command Format - B

Function	Code Data								
POWER ON	P	O	W	R	(SP)	(SP)	(SP)	1	(CR)
POWER OFF	P	O	W	R	(SP)	(SP)	(SP)	0	(CR)
INPUT SELECT HDMI1	I	R	G	B	(SP)	(SP)	3	1	(CR)
INPUT SELECT HDMI2	I	R	G	B	(SP)	(SP)	3	2	(CR)
INPUT SELECT HDBaseT	I	N	E	T	(SP)	(SP)	5	1	(CR)
AV MUTE OFF	I	M	B	K	(SP)	(SP)	(SP)	0	(CR)
AV MUTE ON	I	M	B	K	(SP)	(SP)	(SP)	1	(CR)
MUTE OFF	M	U	T	E	(SP)	(SP)	(SP)	0	(CR)
MUTE ON	M	U	T	E	(SP)	(SP)	(SP)	1	(CR)

NOTE:

- Command formats A and B can be switched using [SETUP] → [CONTROL(1)] → [COMMAND FORMAT] on the on-screen menu.
(→ page 130)
- (SP) in Parameter area means "20H" in ASCII code.
(CR) in Parameter area means "0DH" in ASCII code.
- Contact your local dealer for a full list of the PC Control Codes if needed.

Cable Connection

Communication Protocol

Baud rate	115200/38400/19200/9600/4800 bps
Data length	8 bits
Parity	No parity
Stop bit	1 bit
X on/off	None
Communications procedure	Full duplex

NOTE:

- Depending on the equipment, a lower baud rate may be recommended for long cable runs.

PC CONTROL Port (D-Sub 9P)

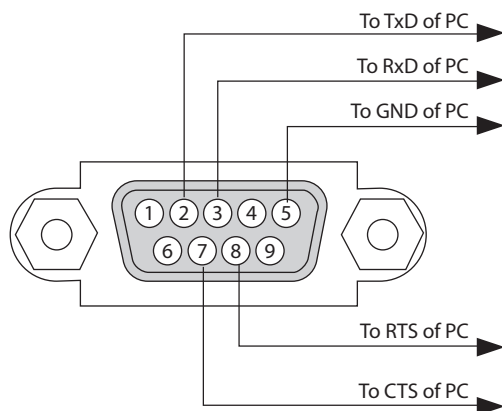

NOTE:

- Pins 1, 4, 6 and 9 are no used.
- Jumper "Request to Send" and "Clear to Send" together on both ends of the cable to simplify cable connection.
- For long cable runs it is recommended to set communication speed within projector menus to 9600 bps.

9-9. About the ASCII Control Command

This device supports the common ASCII Control Command for controlling our projector and monitor. Please visit our website for detailed information about the command.

https://www.sharp-nec-displays.com/dl/en/pj_manual/lineup.html

How to connect with an external device

There are two methods to connect the projector with an external device such as a computer.

1. Connection thru the serial port.

Connects the projector to a computer by a serial cable (a cross cable).

2. Connection via network (LAN/HDBaseT)

Connects the projector to a computer by a LAN cable.

Concerning to the type of LAN cable, please ask to your network administrator.

Connection interface

1. Connection thru the serial port.

Communication Protocol

Item	Information
Baud rate	115200/38400/19200/9600/4800 bps
Data length	8 bits
Parity bit	No parity
Stop bit	1 bit
Flow control	None
Communications procedure	Full duplex

2. Connection via network

Communication Protocol (Connection via LAN)

Item	Information
Communication speed	Set automatically (10/100 Mbps)
Supported standard	IEEE802.3 (10BASE-T)
	IEEE802.3u (100BASE-TX, Auto-Negotiation)

Use the TCP port number 7142 for transmitting and receiving command.

Communication Protocol (Connection via HDBaseT)

Item	Information
Communication speed	100 Mbps
Supported standard	IEEE802.3u (100BASE-TX, Auto-Negotiation)

Use the TCP port number 7142 for transmitting and receiving command.

Parameters for this device

Input command

Input terminal	Response	Parameter
HDMI1	hdmi1	hdmi1 or hdmi
HDMI2	hdmi2	hdmi2
HDBaseT	hdbaset	hdbaset or hdbaset1

Status command

Response	Error Status
error:temp	Temperature error
error:fan	Fan trouble
error:light	Light source trouble
error:lens	Lens trouble
error:system	System trouble

9-10. List of Art-Net DMX parameters

Function	Behavior	Parameter	Note
POWER	OFF	0 – 63	
	No operation	64 – 191	
	ON	192 – 255	
INPUT	No operation	0 – 7	
	HDMI1	8 – 15	
	No operation	16 – 23	
	HDMI2	24 – 31	
	No operation	32 – 39	
	HDBaseT	40 – 47	
	No operation	48 – 255	
BLANK	OFF	0 – 63	
	No operation	64 – 191	
	ON	192 – 255	
SHUTTER	OPEN	0 – 63	
	No operation	64 – 191	
	CLOSE	192 – 255	
FREEZE	OFF	0 – 63	
	No operation	64 – 191	
	ON	192 – 255	
LIGHT ADJUST	No operation	0 – 49	
	Adjusted value	50 – 100	
	No operation	101 – 255	
LENS SHIFT(H)	Adjust Left	0 – 63	
	Stop	64 – 191	
	Adjust Right	192 – 255	
LENS SHIFT(V)	Adjust Down	0 – 63	
	Stop	64 – 191	
	Adjust Up	192 – 255	
FOCUS	Adjust (–)	0 – 63	
	Stop	64 – 191	
	Adjust (+)	192 – 255	
ZOOM	Adjust (–)	0 – 63	
	Stop	64 – 191	
	Adjust (+)	192 – 255	
KEYSTONE(H)	No operation		Adjust +/- with 128 as the center (adjustment value 0).
	Adjusted value		
	No operation		
KEYSTONE(V)	No operation		Adjust +/- with 128 as the center (adjustment value 0).
	Adjusted value		
	No operation		
LOCK	Inoperable	0 – 127	Disables the Art-Net function.
	Operable	128 – 255	Enables the Art-Net function.

9-11. Troubleshooting Check List

Before contacting your dealer or service personnel, check the following list to be sure repairs are needed also by referring to the “Troubleshooting” section in your user’s manual. This checklist below will help us solve your problem more efficiently.

* Print this page and the next page for your check.

Frequency of occurrence:

always sometimes (How often? _____) other (_____)

Power

- No power (POWER indicator does not light blue). See also “Status Indicator (STATUS)”.
- Power cord’s plug is fully inserted into the wall outlet.
- No power even though you press and hold the POWER button.
- Shut down during operation.
 - Power cord’s plug is fully inserted into the wall outlet.
 - [AUTO POWER OFF] is turned off (only models with the [AUTO POWER OFF] function).
 - [OFF TIMER] is turned off (only models with the [OFF TIMER] function).

Video and Audio

- No image is displayed from your PC or video equipment to the projector.
 - Still no image even though you connect the projector to the PC first, then start the PC.
 - Enabling your notebook PC’s signal output to the projector.
 - A combination of function keys will enable/disable the external display. Usually, the combination of the “Fn” key along with one of the 12 function keys turns the external display on or off.
 - No image (blue or black background, no display).
 - Still no image even though you carry out [RESET] in the projector’s menu.
 - Signal cable’s plug is fully inserted into the input terminal
 - A message appears on the screen. (_____)
 - The source connected to the projector is active and available.
 - Still no image even though you adjust the brightness and/or the contrast.
 - Input source’s resolution and frequency are supported by the projector.
- Image is too dark.
 - Remains unchanged even though you adjust the brightness and/or the contrast.
- Image is distorted.
 - Image appears to be trapezoidal (unchanged even though you carry out the [KEYSTONE] adjustment).
- Parts of the image are lost.
 - Still unchanged even though you carry out [RESET] in the projector’s menu.
- Image is shifted in the vertical or horizontal direction.
 - Horizontal and vertical positions are correctly adjusted on a computer signal.
 - Input source’s resolution and frequency are supported by the projector.
 - Some pixels are lost.
- Image is flickering.
 - Still unchanged even though you carry out [RESET] in the projector’s menu.
 - Image shows flickering or color drift on a computer signal.
- Image appears blurry or out of focus.
 - Still unchanged even though you checked the signal’s resolution on PC and changed it to projector’s native resolution.
 - Still unchanged even though you adjusted the focus.
- No sound.
 - Still unchanged even though you adjusted the volume level.
 - AUDIO OUT is connected to your audio equipment (only models with the AUDIO OUT terminal).

Other

- Remote control does not work.
 - No obstacles between the sensor of the projector and the remote control.
 - Projector is placed near a fluorescent light that can disturb the infrared remote controls.
 - Batteries are new and are not reversed in installation.
- Buttons on the projector cabinet do not work (only models with the [CONTROL PANEL LOCK] function)
 - [CONTROL PANEL LOCK] is not turned on or is disabled in the menu.
 - Still unchanged even though you press and hold the EXIT button over 10 seconds.

In the space below please describe your problem in detail.

Information on application and environment where your projector is used

Projector

Model number:

Serial No.:

Date of purchase:

Light module operating time (hours):

REF. LIGHT MODE: NORMAL

SILENT LONG LIFE

Information on input signal:

Horizontal synch frequency [] kHz

Vertical synch frequency [] Hz

Synch polarity H (+) (-)

V (+) (-)

Indicator Message:

POWER Blinks in Blue Green Orange Red
[] cycles

Lights in Blue Green Orange Red

STATUS Blinks in Blue Green Orange Red
[] cycles

Lights in Blue Green Orange Red

LIGHT Blinks in Blue Green Orange Red
[] cycles

Lights in Blue Green Orange Red

TEMP. Blinks in Blue Green Orange Red
[] cycles

Lights in Blue Green Orange Red

Remote control model number:

Signal cable

SHARP standard or other manufacturer's cable?

Model number: Length: inch/m

Distribution amplifier

Model number:

Switcher

Model number:

Adapter

Model number:

Installation environment

Screen size: inch

Screen type: White matte Beads Polarization
 Wide angle High contrast

Throw distance: feet/inch/m

Orientation: Ceiling mount Desktop

Power outlet connection:

- Connected directly to wall outlet
- Connected to power cord extender or other (the number of connected equipment _____)
- Connected to a power cord reel or other (the number of connected equipment _____)

Computer

Manufacturer:

Model number:

Notebook PC / Desktop

Native resolution:

Refresh rate:

Video adapter:

Other:

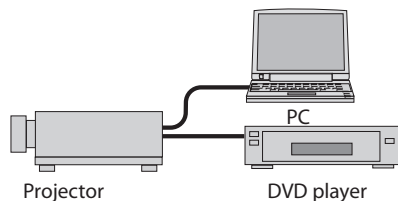

Video equipment

VCR, DVD player, Video camera, Video game or other

Manufacturer:

Model number:

SHARP
SHARP CORPORATION